



WALMCO

— PLEXI & ALUMINUM SYSTEMS —

PRODUCT
CATALOG

HAKKIMIZDA

ABOUT US

WALMCO ALÜMİNYUM SİSTEMLERİ İTHALAT İHRACAT SAN. VE TİC.LTD.ŞTİ.

2010 Yılından itibaren alüminyum korkuluk sistemleri bağlantı elemanları tasarımı, dizaynı ve üretimi konusunda faaliyet göstermektedir.

Üretimini yaptığımız ürünleri yurt içinde ve yurt dışında oluşturduğumuz bayii ağıyla **WALMCO** Markası altında üretimini ve pazarlamasını yapmaktayız.

Firmamız Kurulduğu günden itibaren her geçen gün sahip olduğu bilgi ve birikimini kullanarak gerek ürün yelpazesini gerekse üretim teknolojisine paralel olarak kapasitesini sürekli artırarak sektörde kendine önemli bir yer edinmiştir. **WALMCO ALÜMİNYUM SİSTEMLERİ İTH. İHR. SAN. TİC. LTD. ŞTİ.** yaptığı çalışmalarda maksimum kaliteyi, minimum maliyeti ve en kısa sürede teslimi kendine sistem olarak görmüş ve bunu uygulamayı kendine görev olarak bilmiştir. Firmamız **2020** yılı itibarıyla kurumsallaşma ve markalaşma çalışmalarına hız vererek **ARGE** ve **kalite kontrol birimlerini** daha da genişleterek üretim teknolojilerini ve kapasitesinin artırımına girmiştir.

Bu gün siz değerli iş ortaklarımızın ve yapı sektörünün gereksinimleri doğrultusunda ürünlerinin tasarım ve dizaynını kendi bünyesinde yapabilen ve en düşük maliyetlerde, kaliteden ödün vermeden çok kısa süre üretebilen bir firma haline gelmiştir.

WALMCO ALÜMİNYUM SİSTEMLERİ İTH. İHR. SAN. TİC. LTD. ŞTİ. olarak bu güne kadar yaptığımız çalışmalardan aldığımız güç ile bundan sonrada kendini sürekli yenileyerek, daha sağlam adımlarla yoluna devam edecektir.

WALMCO ALUMINUM SYSTEMS İTHALAT İHRACAT SAN. VE TİC.LTD.ŞTİ.

Since 2010, it has been operating in the design, design and production of aluminum railing systems fasteners.

We produce and market the products we produce under the **WALMCO** Brand with our dealer network that we have established in the country and abroad.

Our company has gained an important place in the sector by continuously increasing its capacity in parallel with both its product range and production technology by using its knowledge and experience it has gained day by day since its establishment. **WALMCO ALUMINUM SYSTEMS IMPORT. İHR. SINGING. TİC. LTD. ŞTİ.** In his studies, he saw maximum quality, minimum cost and delivery in the shortest time as his own system, and it was his duty to implement this. As of **2020**, our company has accelerated its institutionalization and branding efforts, further expanding its **ARGE** and **quality control units** and increasing its production technologies and capacity.

Today, it has become a company that can design and design its products in line with the requirements of you, our valuable business partners and the building sector, and produce in a very short time without sacrificing quality at the lowest costs.

WALMCO ALUMINUM SYSTEMS IMPORT. İHR. SINGING. TİC. LTD. ŞTİ. will continue on its way with more solid steps by constantly renewing itself from now on with the strength we have gained from the work we have done so far.

İÇİNDEKİLER

CONTENTS

5

CAM KANAL KORKULUK SİSTEMLERİ
GLASS CHANNEL RAILING ACCESSORIES



23

KARE KÜPEŞTE AKSESUARLARI
SQUARE HANDRAIL ACCESSORIES



41

ELİPS KÜPEŞTE AKSESUARLARI
ELLİPE HANDRAIL ACCESSORIES



48

YUVARLAK KORKULUK AKSESUARLARI
ROUND RAILING ACCESSORIES



66

BAHÇE ÇİT KORKULUK PROFİLLERİ
GARDEN FENCE RAILING PROFILES



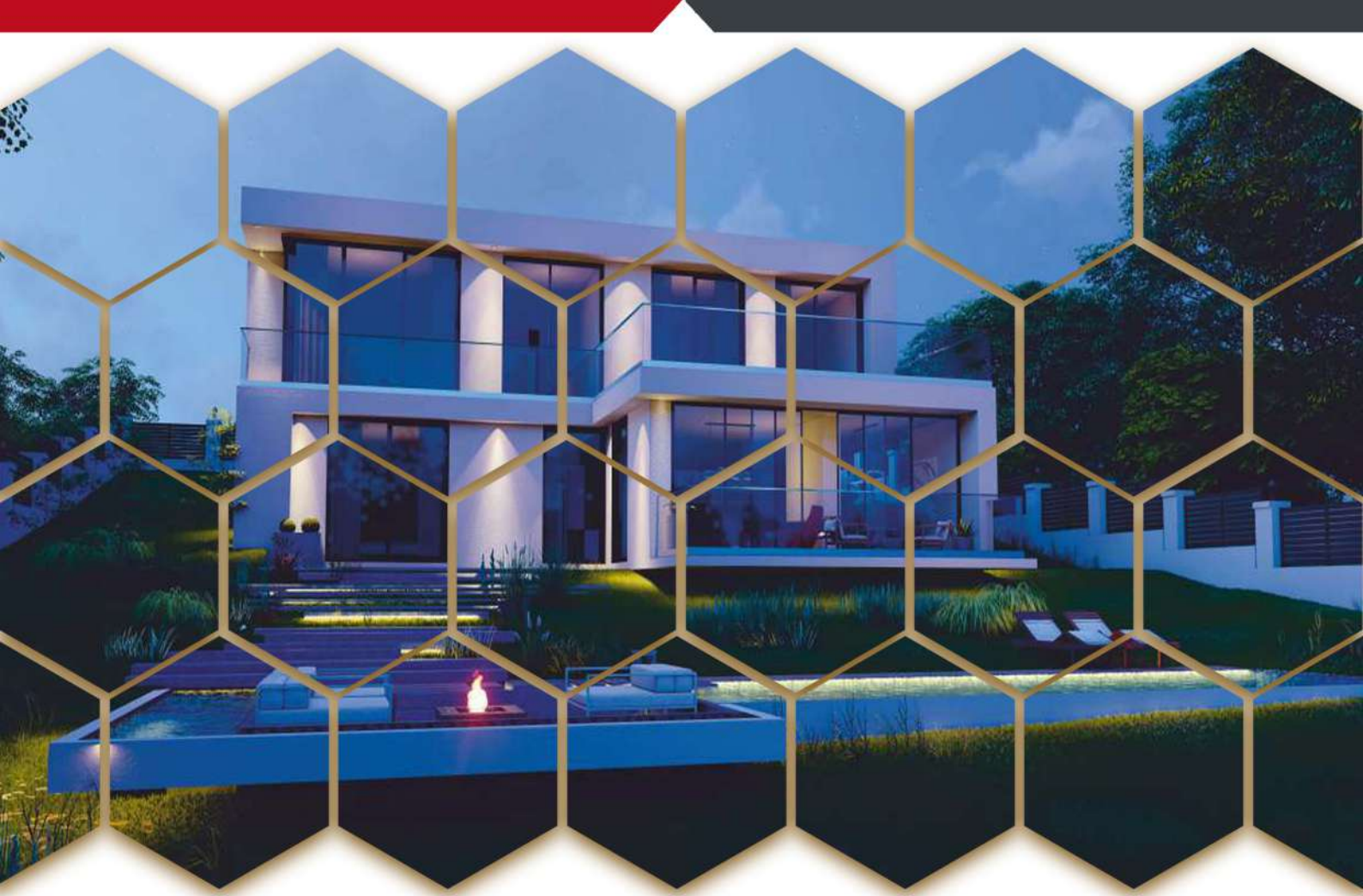

CAM KANAL SİSTEM AKSESUARLARI

GLASS CHANNEL SYSTEM ACCESSORIES

- Cam Taşıyıcı Aksesuarlar
- Glass Carrier Accessories
- Cam Tutamakları ve Spider Bağlantıları
- Glass Handles and Spider Joints
- Dirsek ve Dönüş Bağlantıları
- Elbow and Return Connections
- Contalar ve Kapaklar
- Gaskets and Covers
- Cam Kanal Sistem Profiller
- Glass Channel System Profiles

* WC 10-01

16-20 mm Cam Baza Profili
16-20 mm Glass Base Profile



Cam Yüksekliği : 110 cm (max)
Cam Kalınlığı : 10+10+0,76/1,52
Parçalar Halinde Kullanılabilir (15cm/20cm)
Kapaklarda Renk Seçenekleri Mevcuttur.

Sertifikalı Onaylı Ürün

Glass Height : 110 cm(max)
With Glass : 10+10+0,76/1,52
Availability for partial using (15cm/20cm)
There are options of color for the covers

Certificated System

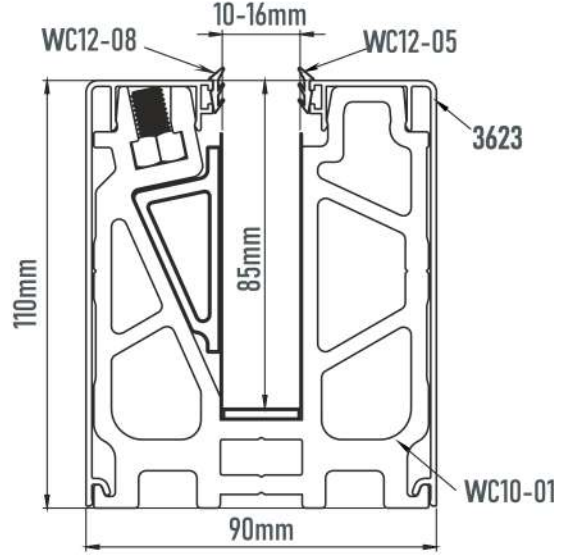

* WC 10-06

Baza Profil Tapası
Base Profile Plug



* 3623

Zemin Üstü Cam Kanal Kapağı
0,683 kg/mt

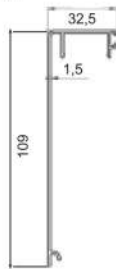

* 3621

Zemin Altı Cam Kanal Kapağı
0,306 kg/mt

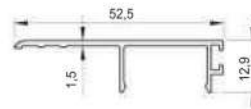

* WC 12-05

Cam Kanal Contası (1 mt)
Glass Mortise Gasket (1 mt)



UYGULAMA DETAYLARI Applications Details

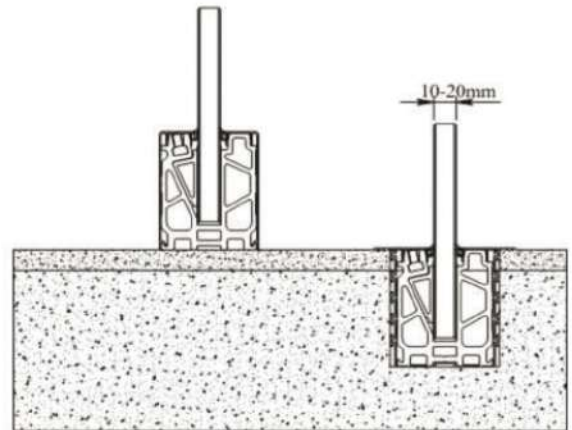
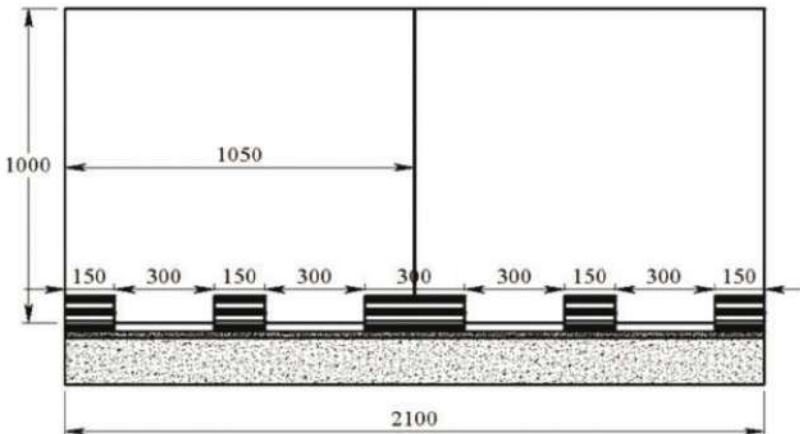

* WC 10-12/A

16-20 mm Cam Baza Profili
16-20 mm Glass Base Profile

Cam Yüksekliği : 110 cm (max)
Cam Kalınlığı : 10+10+0,76/1,52
Parçalar Halinde Kullanılabilir (15cm/20cm)
Kapaklarda Renk Seçenekleri Mevcuttur.

Sertifikalı Onaylı Ürün

Glass Height : 110 cm(max)
With Glass : 10+10+0,76/1,52
Availability for partial using (15cm/20cm)
There are options of color for the covers

Certificated System

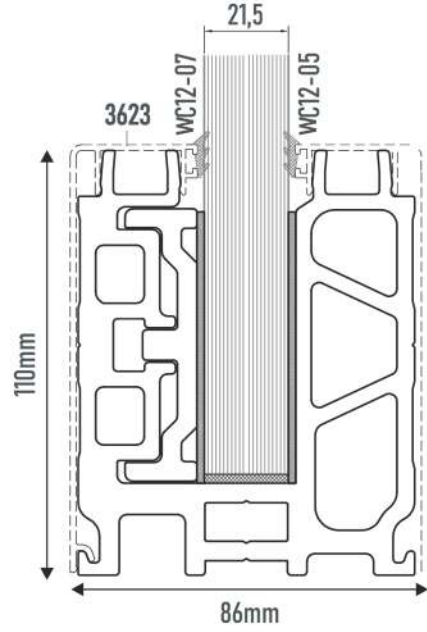

* WC 10-06

Baza Profil Tapası
Base Profile Plug



* 3623

Zemin Üstü Cam Kanal Kapağı
0,683 kg/mt

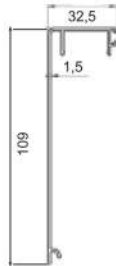

* WC 12-05

Cam Kanal Contası (1 mt)
Glass Mortise Gasket (1 mt)



UYGULAMA DETAYLARI Applications Details

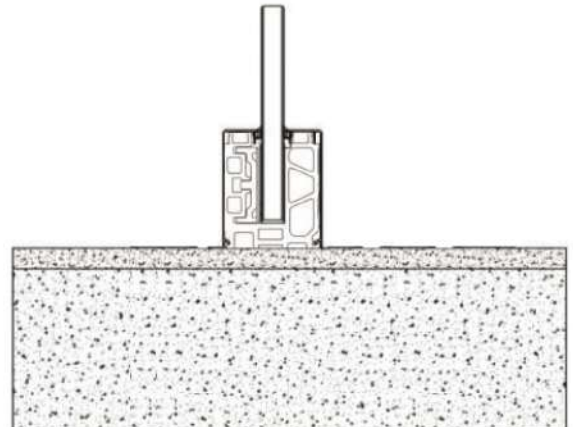
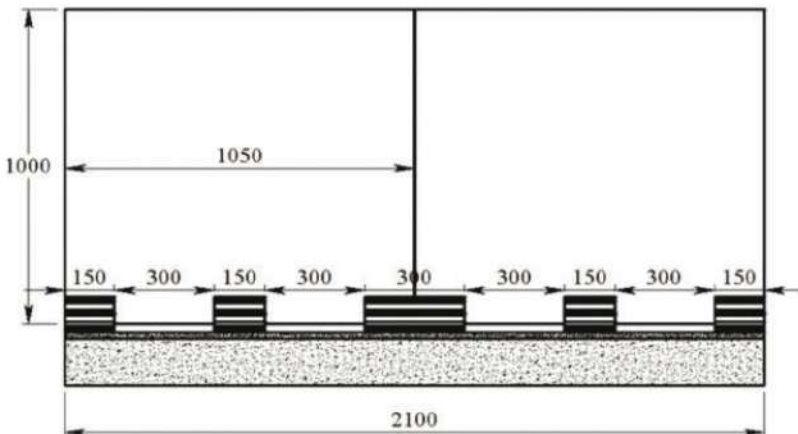

* WC 10-10/A

Yandan Montaj 16-20 mm Cam Baza Profili
Aside Mounting 16-20 mm Glass Base Profile



Cam Yüksekliği : 110 cm (max)
Cam Kalınlığı : 10+10+0,76/1,52
Parçalar Halinde Kullanılabilir (15cm/20cm)
Kapaklarda Renk Seçenekleri Mevcuttur.

Sertifikalı Onaylı Ürün

Glass Height : 110 cm(max)
With Glass : 10+10+0,76/1,52
Availability for partial using (15cm/20cm)
There are options of color for the covers

Certificated System

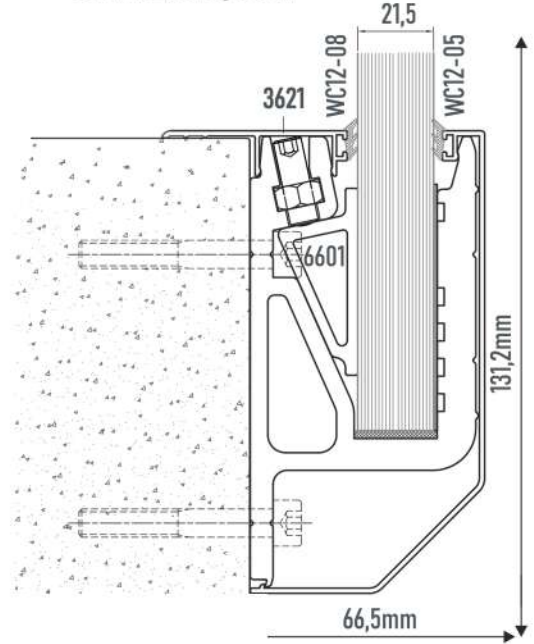

* WC 10-11/A

Yandan Montaj Baza Profil Tapası
Aside Mounting Base Profile Plug



* 10569

Yandan Montaj Cam Kanal Kapağı
0,809 kg/mt



* 3621

Zemin Altı Cam Kanal Kapağı
0,306 kg/mt

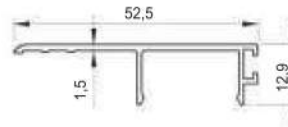

* WC 12-05

Cam Kanal Contası (1 mt)
Glass Mortise Gasket (1 mt)



UYGULAMA DETAYLARI Applications Details



* WC 11-01

Cam Kanal Profili 12-16 mm
Glass Base Profile for 12-16 mm



Cam Yüksekliği : 100 cm (max)
Cam Kalınlığı : 8+8+0,76/1,52
Kapaklarda Renk Seçenekleri Mevcuttur.
Sertifikalı Onaylı Ürün

Glass Height : 100 cm(max)
With Glass : 8+8+0,76/1,52
There are options of color for the covers
Certificated System

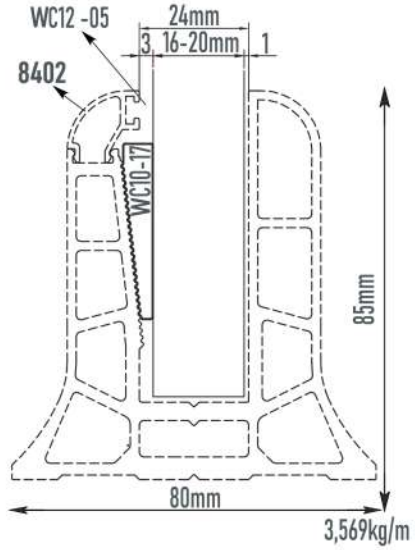

* WC 11-02

Cam Kanal Profili 10-12 mm
Glass Base Profile for 10-12 mm



Cam Yüksekliği : 100 cm (max)
Cam Kalınlığı : 6+6+0,76/1,52
Kapaklarda Renk Seçenekleri Mevcuttur.
Sertifikalı Onaylı Ürün

Glass Height : 100 cm(max)
With Glass : 6+6+0,76/1,52
There are options of color for the covers
Certificated System

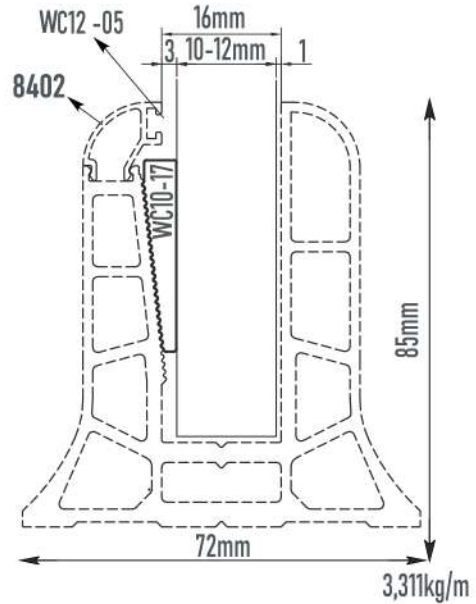

* WC 10-11/A

Cam Kanal Tapası (8884-8401)
Glass Channel Plug



* 8402

Cam Kanal Profili
0,142 kg/mt



* WC 12-05

Cam Kanal Contası (1 mt)
Glass Mortise Gasket (1 mt)



* WC 10-17

Cam Kanal Kaması (8884)(16mm)
Glass Channel



* WC 10-17/A

Cam Kanal Kaması (8401)(12mm)
Glass Channel



* WC 10-13/A

10-12 mm Cam Baza Profili
10-12 mm Glass Base Profile



Cam Yüksekliği : 100 cm (max)
Cam Kalınlığı : 6+6+0,76/1,52
Parçalar Halinde Kullanılabilir (15cm/20cm)
Kapaklarda Renk Seçenekleri Mevcuttur.

Sertifikalı Onaylı Ürün

Glass Height : 100 cm(max)
With Glass : 6+6+0,76/1,52
Availability for partial using (15cm/20cm)
There are options of color for the covers

Certificated System

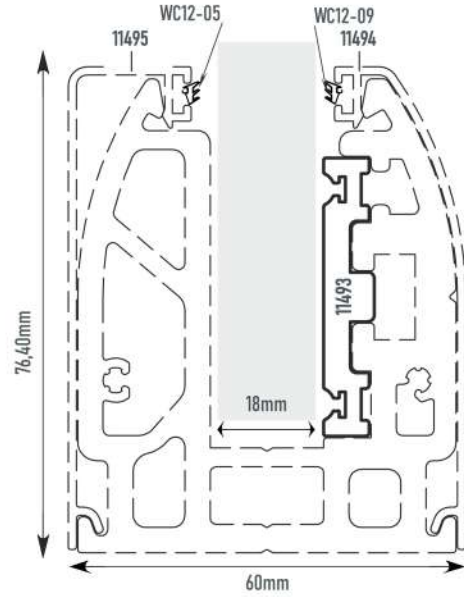

* WC 10-14/B

Baza Profil Tapası
Base Profile Plug



* 11495

Zemin Üstü Cam Kanal Kapağı
0,395 kg/mt

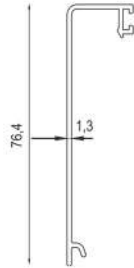

* 3621

Zemin Altı Cam Kanal Kapağı
0,370 kg/mt

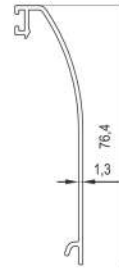

* WC 12-05

Cam Kanal Contası (1 mt)
Glass Mortise Gasket (1 mt)



UYGULAMA DETAYLARI Applications Details



* WC 11-04

16-20 mm Cam Baza Profili
16-20 mm Glass Base Profile

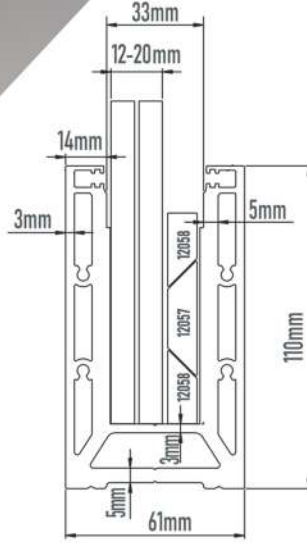
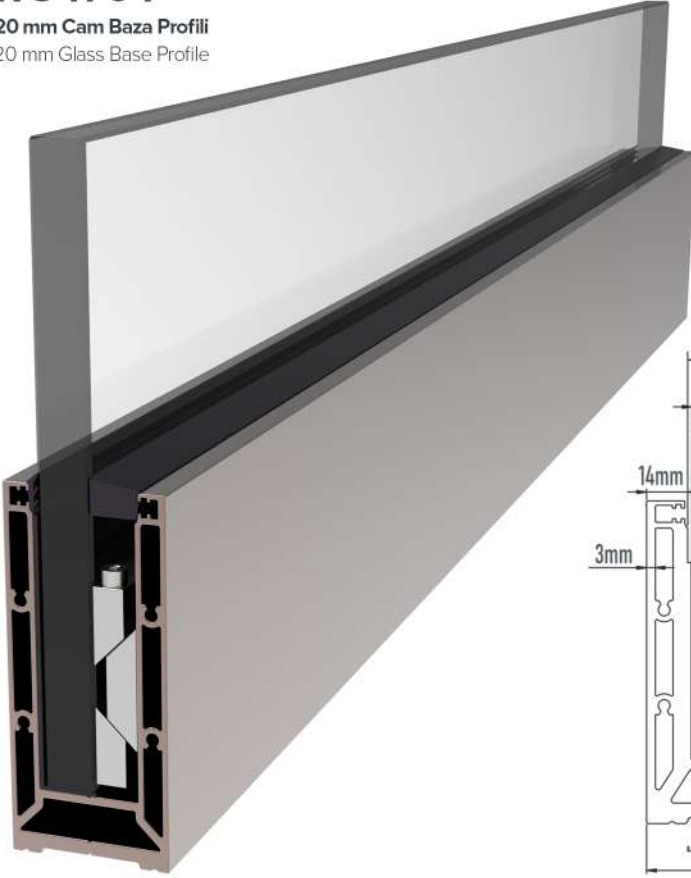

Cam Yüksekliği : 100 cm (max)
Cam Kalınlığı : 10+10+0,76/1,52
Parçalar Halinde Kullanılabilir (15cm/20cm)
Kapaklarda Renk Seçenekleri Mevcuttur.

Sertifikalı Onaylı Ürün

Glass Height : 100 cm(max)
With Glass : 10+10+0,76/1,52
Availability for partial using (15cm/20cm)
There are options of color for the covers
Certificated System

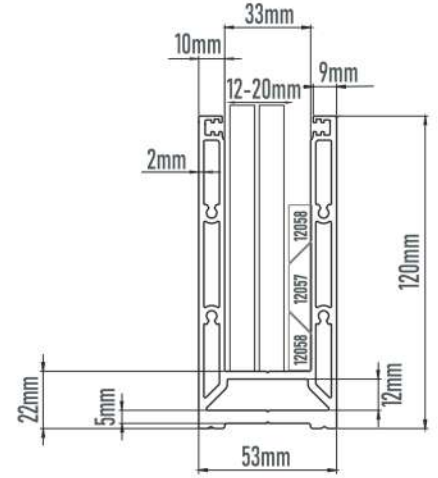

* WC 11-03/B

Baza Profil Tapası
Base Profile Plug



* WC 11-03/A

WC 11-03 Dönüş
WC 11-03 Turning



* WC 12-05

Cam Kanal Contası (1 mt)
Glass Mortise Gasket (1 mt)



* 1210

Cam Kanal Contası (1 mt)
Glass Mortise Gasket (1 mt)



UYGULAMA DETAYLARI Applications Details





* WC 10-15

10-16 mm Cam Taşıyıcı

Hold Ground Glass Handle For 10-16mm

Cam Yüksekliği : 100 cm (max)
Cam Kalınlığı : 8+8+0,76/1,52
Renk Seçenekleri Mevcuttur.
Sertifikalı Onaylı Ürün

Glass Height : 100 cm(max)
With Glass : 8+8+0,76/1,52
There are options of color
Certificated System

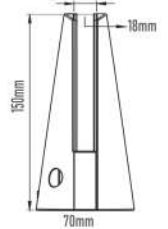
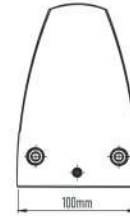

* WC 10-09

10-12 mm Cam Taşıyıcı

Hold Ground Glass Handle For 10-12mm

Cam Yüksekliği : 100 cm (max)
Cam Kalınlığı : 6+6+0,76/1,52
Renk Seçenekleri Mevcuttur.
Sertifikalı Onaylı Ürün

Glass Height : 100 cm(max)
With Glass : 6+6+0,76/1,52
There are options of color
Certificated System

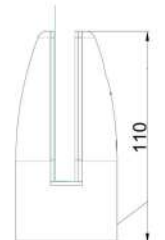
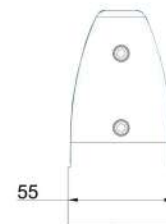



* WC 10-15/A

10-16 mm Cam Taşıyıcı

Hold Ground Glass Handle For 10-16mm

Cam Yüksekliği : 100 cm (max)

Cam Kalınlığı : 8+8+0,76/1,52

Renk Seçenekleri Mevcuttur.

Sertifikalı Onaylı Ürün

Glass Height : 100 cm(max)

With Glass : 8+8+0,76/1,52

There are options of color

Certificated System

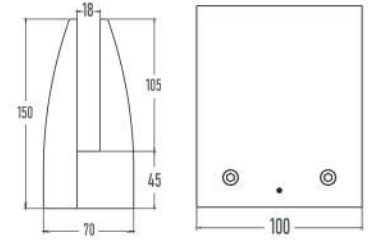

* WC 10-09/A

10-12 mm Cam Taşıyıcı

Hold Ground Glass Handle For 10-12mm

Cam Yüksekliği : 100 cm (max)

Cam Kalınlığı : 6+6+0,76/1,52

Renk Seçenekleri Mevcuttur.

Sertifikalı Onaylı Ürün

Glass Height : 100 cm(max)

With Glass : 6+6+0,76/1,52

There are options of color

Certificated System

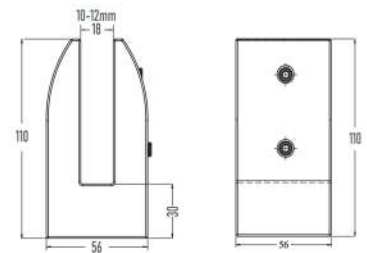



* WC 10-15/B

16-20 mm Cam Taşıyıcı

Hold Ground Glass Handle For 16-20mm

Cam Yüksekliği : 100 cm (max)

Cam Kalınlığı : 10+10+0,76/1,52

RAL Seçenekleri Mevcuttur.

Sertifikalı Onaylı Ürün

Glass Height : 100 cm(max)

With Glass : 10+10+0,76/1,52

RAL color options available

Certificated System

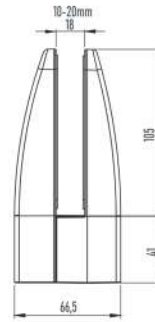
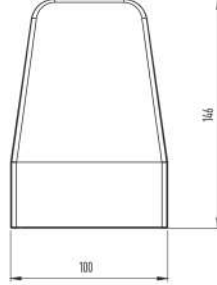

* WC 10-15/C

16-20 mm Cam Taşıyıcı

Hold Ground Glass Handle For 16-20mm

Cam Yüksekliği : 100 cm (max)

Cam Kalınlığı : 10+10+0,76/1,52

RAL Seçenekleri Mevcuttur.

Sertifikalı Onaylı Ürün

Glass Height : 100 cm(max)

With Glass : 10+10+0,76/1,52

RAL color options available

Certificated System

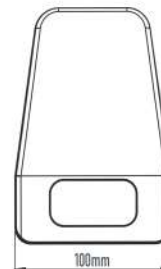
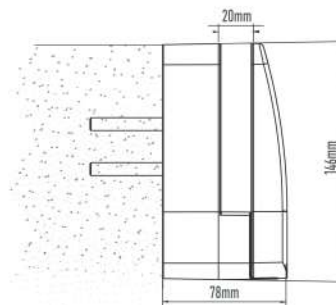



* WC 10-24

16-20 mm Cam Taşıyıcı

Hold Ground Glass Handle For 16-20mm

Cam Yüksekliği : 100 cm (max)

Cam Kalınlığı : 10+10+0,76/1,52

RAL Seçenekleri Mevcuttur.

Sertifikalı Onaylı Ürün

Glass Height : 100 cm(max)

With Glass : 10+10+0,76/1,52

RAL color options available

Certificated System

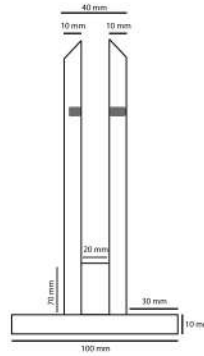
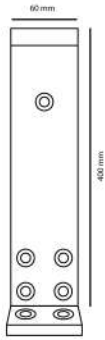

* WC 10-23

10-12 mm Cam Taşıyıcı

Hold Ground Glass Handle For 10-12mm

Cam Yüksekliği : 100 cm (max)

Cam Kalınlığı : 6+6+0,76/1,52

RAL Seçenekleri Mevcuttur.

Sertifikalı Onaylı Ürün

Glass Height : 100 cm(max)

With Glass : 6+6+0,76/1,52

RAL color options available

Certificated System

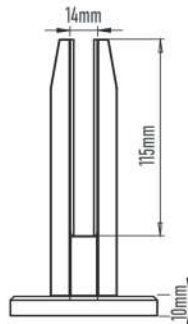
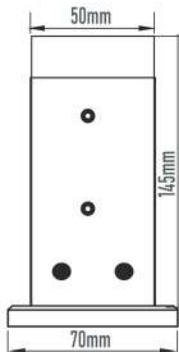



* WC 10-18/A

10 mm Cam Taşıyıcı

Hold Ground Glass Handle For 10 mm

Cam Yüksekliği : 100 cm (max)
Cam Kalınlığı : 5+5+0,76/1,52
RAL Seçenekleri Mevcuttur.
Sertifikalı Onaylı Ürün

Glass Height : 100 cm(max)
With Glass : 5+5+0,76/1,52
RAL color options available
Certificated System

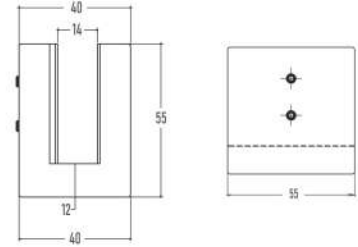

* WC 10-18

10 mm Cam Taşıyıcı

Hold Ground Glass Handle For 10 mm

Cam Yüksekliği : 100 cm (max)
Cam Kalınlığı : 5+5+0,76/1,52
RAL Seçenekleri Mevcuttur.
Sertifikalı Onaylı Ürün

Glass Height : 100 cm(max)
With Glass : 5+5+0,76/1,52
RAL color options available
Certificated System

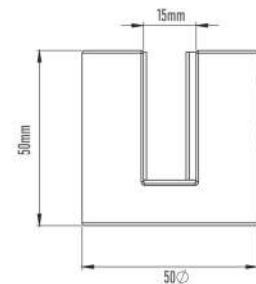



* WC 10-16

10-12 mm Cam Taşıyıcı

Hold Ground Glass Handle For 10-12 mm

Cam Yüksekliği : 100 cm (max)

Cam Kalınlığı : 6+6+0,76/1,52

RAL Seçenekleri Mevcuttur.

Sertifikalı Onaylı Ürün

Glass Height : 100 cm(max)

With Glass : 6+6+0,76/1,52

RAL color options available

Certificated System

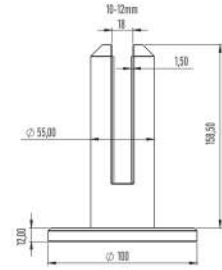

* WC 10-19

Ø50 Cam Yandan Bağlantı Spider

Ø50 Glass Side Connection Set

Cam Yüksekliği : 100 cm (max)

Cam Kalınlığı : 6+6+0,76/1,52

RAL Seçenekleri Mevcuttur.

Sertifikalı Onaylı Ürün

Glass Height : 100 cm(max)

With Glass : 6+6+0,76/1,52

RAL color options available

Certificated System



* WC 10-20

Ø40 Cam Yandan Bağlantı Spider

Ø40 Glass Side Connection Set





* WC 10-21

50'lik Boru Cam Bağlantı Mafsalı
Ø50 Pipe Glass Connector Joint



* WC 10-22

T Bağlantılı Cam Mafsalı
T Connector Glass Joint



* WA 22-10

50'lik Boru Cam Bağlantı Mafsalı
Ø50 Pipe Glass Connector Joint



* WA 22-11

Cam Yandan Bağlantı Takımı
Glass Lateral Connector Set



* WA 25-13

Cam Spider Bağlantı Mafsalı
Glass Spider Connector Set



* WK 25-18

T Bağlantılı Cam Spider Mafsalı
T Connector Glass Spider Set



* WK 15-46/A

25x60 90° Kanallı Dönüş
25x60 90° Channel Rotation



* WK 15-48/A

30x80 90° Kanallı Dönüş
30x80 90° Channel Rotation



* WE 15-09

30x80 Elips 90° Kanallı Dönüş
30x80 Ellipse 90° Channel Rotation



* WC 10-25

30x25 Cam Kanal Duvar Flanşı
30x25 Glass Channel Wall Flange



* WC 10-26

30x25 Cam Kanal Bileziği
30x25 Glass Channel Ring



* WC 10-27

30x25 Profil Tapası
30x25 Profile Plug



* WC 10-28

30x25 90° Kanallı Dönüş
30x25 90° Mortise Turning



* WC 12-01

Cam Kanal Contası 12 mm
Glass Channel Gasket 12mm



* WC 12-02

Cam Kanal Contası 16 mm
Glass Channel Gasket 16mm



* WC 12-03

Cam Kanal Contası 20 mm
Glass Channel Gasket 20mm



* WC 12-04

Led Kapak
Led Cover



* WC 12-05

Cam Kanal Contası (1mt)
Glass Mortise Gasket



* WC 12-06

28x30 Profil Contası (7311)
28x30 Profile Gasket



* WC 12-07

Cam Kanal Contası (WC 10-12)
Glass Mortise Gasket (WC 10-12)



* WC 12-08

Cam Kanal Contası (WC 10-01)
Glass Mortise Gasket (WC 10-01)



* WC 12-09

Cam Kanal Contası (WC 10-13)
Glass Channel Gasket (WC 10-13)



* WC 12-10

Cam Kanal Contası (WC 11-03)
Glass Channel Gasket (WC 11-03)

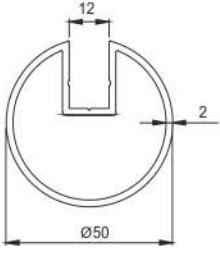

*** 4723**
50'lik Kanallı 12 mm
1,026 kg/mt

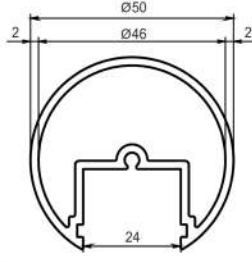

*** 3809**
50'lik Kanallı Boru 24mm
1,050 kg/mt

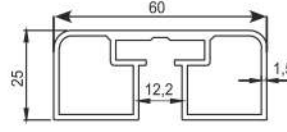

*** 4893**
25x60 Kare Profil 12mm
0,931 kg/mt

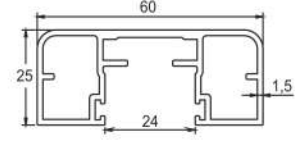

*** 6610**
25x60 Kare Profil 24mm
0,887 kg/mt

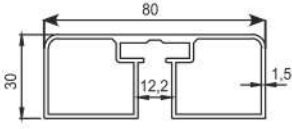

*** 4894**
30x80 Kare Profil 12mm
1,187 kg/mt

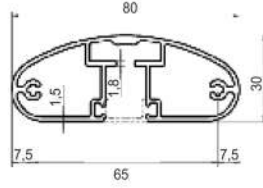

*** 7800**
Elips Cam Profili
1,221 kg/mt

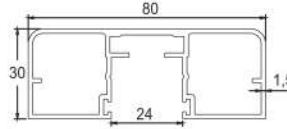

*** 6611**
30x80 Kare Profil 24mm
1,132 kg/mt

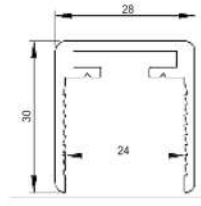

*** 7311**
Cam U Profili
0,528 kg/mt

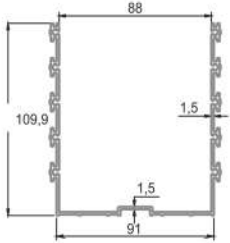

*** 6603**
Zemin Altı Kanal Profili
1,806 kg/mt

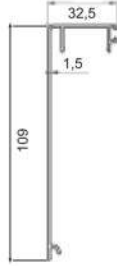

*** 3623**
Zemin Üstü Cam Kanal Kapağı
0,683 kg/mt

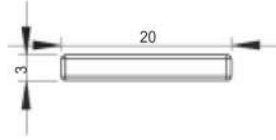

*** 2572**
0,163 kg/mt

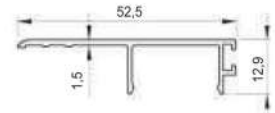

*** 3621**
Zemin Altı Cam Kanal Kapağı
0,306 kg/mt

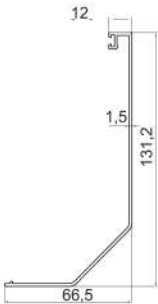

*** 10569**
Yandan Montaj Cam Kanal Kapağı
0,809 kg/mt

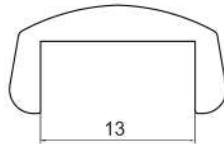

*** 8403**
Cam U Profili
0,173 kg/mt

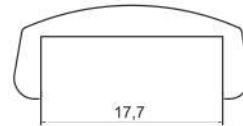

*** 8791**
Cam U Profili
0,216 kg/mt

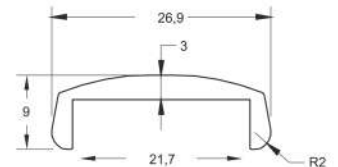

*** 12281**
Cam U Profili
0,234 kg/mt

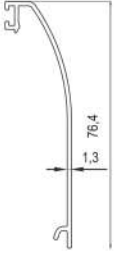

*** 11494**
Zemin Üstü Cam Kanal Profili
0,370 kg/mt

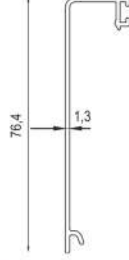

*** 11495**
Zemin Üstü Cam Kanal Profili
0,395 kg/mt

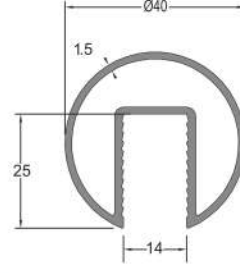

*** 12150**
40'lık Kanallı 14mm
0,729 kg/mt

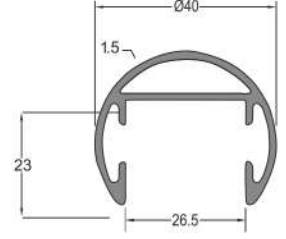

*** 12151**
40'lık Kanallı 26,5mm
0,621 kg/mt

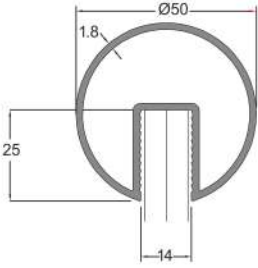

*** 12152**
50'lık Kanallı 14mm
1,003 kg/mt

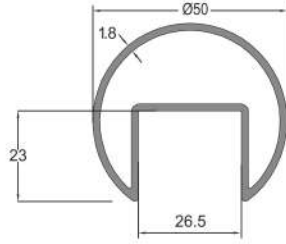

*** 12153**
50'lık Kanallı Boru 26,5mm
0,946 kg/mt



*** 12418**
50'lık Ledli Boru
0,960 kg/mt

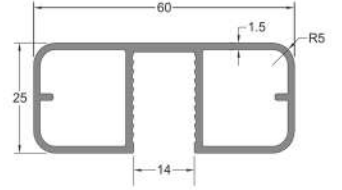

*** 12154**
25x60 Kare Camlı Profil 14mm
0,829 kg/mt

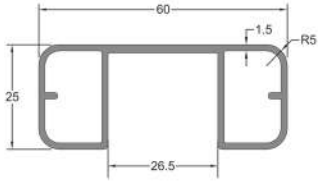

*** 12155**
25x60 Kare Camlı Profil 26,5mm
0,781 kg/mt

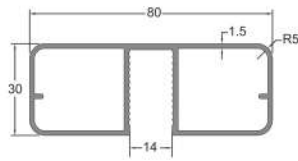

*** 12156**
30x80 Kare Camlı Profil 14mm
1,092 kg/mt

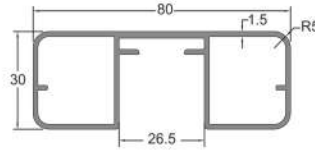

*** 12157**
30x80 Kare Camlı Profil 26,5mm
1,076 kg/mt

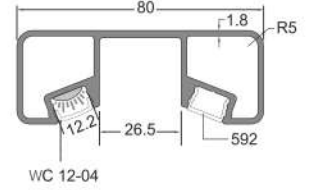

*** 12417**
30x80 Kare Ledli Profil 26,5mm
1,289 kg/mt

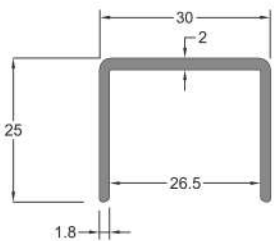

*** 12159**
Cam U Profil 26,5mm
0,382 kg/mt

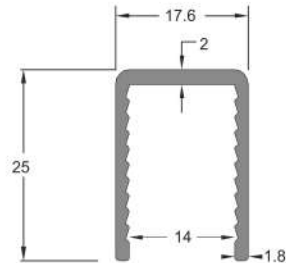

*** 12158**
Cam U Profil 14mm
0,293 kg/mt





KARE KÜPEŞTE AKSESUARLARI

SQUARE RAILING ACCESSORIES

- Dikme ve Profil Flanşları
- Strut's and Profile Flange
- Bilezikler ve Mafsal Bağlantılar
- Rings and Joint Connection
- Dirsek ve Dönüş Bağlantıları
- Elbow and Return Connections
- Tapalar ve Kapaklar
- Plug and Covers
- Cam Tutamakları ve Aksesuarlar
- Glass Handle and Accessories
- Kare ve Lama Dikmeler
- Square and Lama Strut's
- Profiller
- Profiles



* WK 10-26

40x40 Kare Dikme Flanşı (Eko)
40x40 Square Strut's Flange (Eco)



* WK 10-27

40x40 Kare Dikme U Flanş
40x40 Square Strut's U Flange



* WK 10-28

40x40 Kare Dikme Flanşı
40x40 Square Strut's Flange



* WK 10-29

25x50 Dikme Flanşı
25x50 Strut's Flange



* WK 10-30

25x60 Kare Yandan 2 Delikli Flanş
25x60 Square 2 Hole Flange



* WK 10-31

30x80 Kare Yandan 2 Delikli Flanş
30x80 Square 2 Hole Flange



* WK 10-32

40x40 Kare Dıştan Vidalı Flanş
40x40 Square Screwed Flange



* WK 10-32/1

40x40 Kare Flanş Kapağı
40x40 Square Flange Cover



* WK 10-33

40x40 Kare Kapaklı Flanş
40x40 Square Strut's Flange



* WK 10-34

25x60 Kare Kanallı Boru Flanşı
40x40 Square Slotted Pipe Flange



* WK 10-35

25x60 Kare Cam Kanallı Flanş
25x60 Square Channel Flange



* WK 10-36

25x60 Kare Delikli Boru Flanşı
25x60 Square 2 Holed Flange



* WK 10-37

70x70 Kare Baba Flanşı
70x70 Square Strut's Flange



* WK 10-38

32x25 Kare Boru Flanşı Alyanlı
32x25 Square Pipe Flange



* WK 10-39

25x60 Kare Boru Bağlantı Flanşı
25x60 Square Pipe Connection Flange



* WK 10-40

30x80 Kare Kanallı Boru Flanşı
30x80 Square Channel Pipe Flange



* WK 10-41

30x80 Kare Cam Kanallı Flanş
30x80 Square Channel Flange



* WK 10-42

40x40 Flanş Ahşap Ankrāj
30x80 Square 2 Hole Flange



* WK 10-43

14x14 Kare Boru Flanşı
14x14 Square Pipe Flange



* WK 11-10

40x40 Kare Dikme Yarıklı Tapa
40x40 Square Plug Planting



* WK 12-04

40x40 Kare Dikme T Bağlantı
40x40 Square Strut's T Connection



* WK 13-11

40x40 Kare Dikme Hareketli Mafsal
40x40 Square Joint Kit



* WK 13-15

40x40 Kare Dikme Mafsal Takımı
40x40 Square Joint Set



* WK 13-16

25x50 Dikme Mafsal Takımı
25x50 Strut's Joint Set



* WK 13-17

25x50 Dikme Mafsal Takımı
25x50 Strut Joint Kit



* WK 14-17

40x40 Kare Dikme Sabit Mafsal
40x40 Square Strut Stationary Joint



* WK 14-18

40x40 Kare Dikme Sabit Mafsal
40x40 Square Strut Stationary Joint



* WK 14-19

40x40 Kare Dikme Sabit Mafsal
40x40 Square Strut Stationary Joint



* WK 14-20

40 lık Dikme Sabit T Mafsal
Ø40 Strut Stationary T Joint



* WK 14-21

40x40 Kare Dikme Sabit Mafsal
40x40 Square Strut Joint (4162 Profile)



* WK 14-22

25x50 Dikme Sabit Mafsal
25x50 Strut Fixed Joints



* WK 14-23

40x40 Dikme Sabit Ara Bağlantı
40x40 Square Fixed Connector



* WK 15-21

14x14 Hareketli Dirsek
14x14 Adjustable Elbow



* WK 15-22

14x14 Çok Hareketli Dirsek
14x14 Multi Angle Elbow



* WK 15-23

14x14 Kare 90° Dirsek
14x14 Square 90° Elbow



* WK 15-24

14x14 Kare 135° Dirsek
14x14 Square 135° Elbow



* WK 15-25

32x25 Hareketli Bağlantı Takımı
32x25 Movable Connection Kit



* WK 15-26

25x60 135° Dönüş Takımı
25x60 135° Turning Kit



* WK 15-27

25x60 135° Hareketli Duvar Takımı
25x60 135° Movable Wall Kit



* WK 15-28

25x60 90° Hareketli Dönüş Takımı
25x60 90° Movable Turning Kit



* WK 15-30

25x60/30x80 Köşe Bağlantı
25x60/30x80 Corner Connection



* WK 15-31

25x60 Çok Açılı Dönüş Takımı
25x60 Multi Angle Movable Turning



* WK 15-32

25x60 Mafsalı 90° Dönüş
25x60 90° Movable Turning Kit



* WK 15-33

25x60 Mafsalı Çok Açılı Dönüş
25x60 Multi Angle Movable Turning



* WK 15-35

25x60/30x80 Mafsalı 90° Köşe
25x60/30x80 90° Turning Kit



* WK 15-36

14x14 Kare 90° Dirsek
14x14 Square 90° Elbow



* WK 15-37

14x14 Kare 135° Dirsek
14x14 Square 135° Elbow



* WK 15-38

25x60 90° Hareketli Dirsek
25x60 90° Movable Turning Elbow



* WK 15-39

25x60/30x80 Köşe Bağlantı
25x60/30x80 Corner Connection



* WK 15-40

25x60 135° Dönüş Takımı
25x60 135° Turning Kit



* WK 15-41

25x60/30x80 Mafsalı 90° Köşe
25x60/30x80 90° Turning Kit



* WK 15-42

40x40 Mafsalı Çok Açılı Dönüş
40x40 Multi Angle Movable Turning



* WK 15-43

30x80 Çok Açılı Dönüş Takımı
30x80 Multi Angle Movable Turning



* WK 15-44

30x80 Mafsalı Açılı Dönüş Takımı
30x80 Multi Angle Movable Turning



* WK 15-45

25x60 90° Cam Kanallı Dirsek
25x60 90° Glass Channel Elbow



* WK 15-46

25x60 90° Cam Kanallı Dirsek
25x60 90° Glass Channel Elbow



* WK 15-46/A

25x60 90° Kanallı Köşe Dönüş
25x60 90° Channel Turning Kit



* WK 15-46/B

25x60 90° Köşe Dönüş
14x14 Square 90° Elbow



* WK 15-46/C

25x60 135° Köşe Dönüş
25x60 135° Elbow



* WK 15-47

30x80 90° Kanallı Hareketli Dirsek
30x80 90° Channel Turning Elbow



* WK 15-48

30x80 90° Cam Kanallı Dönüş
30x80 90° Glass Channel Turning



* WK 15-48/A

25x60 90° Kanallı Dönüş
25x60 90° Channel Turning

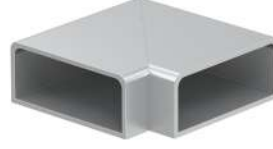

* WK 15-48/B

30x80 90° Dönüş
30x80 90° Rotation



* WK 15-48/C

30x80 135° Dönüş
30x80 135° Rotation



* WK 15-49

30x80 90° Sağ Hareketli Dönüş
30x80 90° Right Movable Turn



* WK 15-50

30x80 90° Sol Hareketli Dönüş
30x80 90° Left Movable Turn



* WK 15-51

30x80 90° Çok Hareketli Dönüş
30x80 90° Multi Movable Turn



* WK 15-52

30x80 90° Hareketli Dönüş
30x80 90° Movable Turn



* WK 15-53

30x80 90° Hareketli Dönüş
30x80 90° Movable Turn



* WK 15-54

30x80 90° Çok Hareketli Dönüş
30x80 90° Multi Movable Turn



* WK 15-55

30x80 90° Köşe Dönüş
30x80 90° Elbow



* WK 15-56

25x60 90° Sağ Hareketli Dirsek
25x60 90° Right Movable Elbow



*** WK 15-57**
25x60 90° Sol Hareketli Dönüş
25x60 90° Left Movable Turn



*** WK 15-58**
25x60 90° Çok Hareketli Dönüş
25x60 90° Multi Movable Turn



*** WK 15-59**
25x60 90° Mafsallı Sağ Dönüş
25x60 90° Jointed Right Turning



*** WK 15-60**
25x60 90° Mafsallı Sol Dönüş
25x60 90° Jointed Left Turning



*** WK 15-61**
25x60 90° Çok Hareketli Dönüş
25x60 90° Multi Movable Turn



*** WK 15-62**
25x60 90° Mafsallı Dönüş
25x60 90° Jointed Turning



*** WK 15-63**
25x32 90° Kanallı Dönüş
25x32 90° Channel Turning



*** WK 15-64**
27x20 90° Kanallı Dönüş
27x20 90° Channel Turning



*** WK 15-65**
30x80 135° Dönüş Takımı
30x80 135° Rotation Team



*** WK 15-66**
30x80 135° Duvar Takımı
30x80 135° Wall team

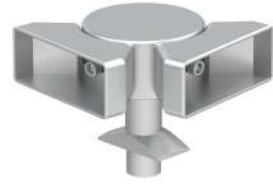

*** WK 15-67**
25x60/25x50 Dikme 90° Dönüş
25x60/25x50 Strut 90° Elbow



*** WK 15-68**
25x60 Mafsallı Çok Açılı Dönüş
25x60 Multi-Angle Turn Hinged Team



* WK 15-69

25x60/30x80 90° Köşe Bağantı
25x60/30x80 90° Turn Connection



* WK 15-70

25x60/30x80 90° Hareketli Köşe
25x60/30x80 90° Movable Turn



* WK 15-71

25x60 90° Mafsallı Sağ Dönüş
25x60 90° Jointed Right Turning



* WK 15-72

25x60 90° Mafsallı Sol Dönüş
25x60 90° Jointed Left Turning



* WK 15-73

25x60 90° Çok Hareketli Dönüş
25x60 90° Multi Movable Turn



* WK 15-74

25x60 90° Mafsallı Dönüş
25x60 90° Jointed Turning



* WK 16-01

25x60 Cam Kanallı Boru Bilezik
25x60 Glass Channel Pipe Ring



* WK 16-02

30x80 Cam Kanallı Boru Bilezik
30x80 Glass Channel Pipe Ring



* WK 16-03

25x60 Kanallı Boru Bilezik
25x60 Channel Pipe Ring



* WK 16-04

30x80 Kanallı Boru Bilezik
30x80 Channel Pipe Ring



* WK 16-05

32x25 Kare Boru Bileziği
32x25 Square Pipe Ring



* WK 16-06

25x60 Kare Boru Bileziği
25x60 Square Pipe Ring



*** WK 16-07**

30x80 Kare Boru Bileziği
30x80 Square Pipe Ring



*** WK 16-08**

14x14 Kare Boru Bileziği
14x14 Square Pipe Ring



*** WK 16-09**

27x20 Kare Boru Bileziği
27x20 Square Pipe Ring



*** WK 16-10**

25x32 Kare Kanallı Boru Bilezik
25x32 Square Pipe ring



*** WK 16-11**

14x14 Kare Ara Bağlantı
14x14 Square Interconnect



*** WK 17-11**

14x14 Kare Boru Tapası
14x14 Square Pipe Plug



*** WK 17-12**

25x60 Kare Boru Tapası
25x60 Square Pipe Plug



*** WK 17-13**

40x40 Kare Dikme Tapası
40x40 Square Pipe Plug



*** WK 17-14**

30x80 Kare Boru Tapası
25x60 Square Pipe Plug



*** WK 17-15**

30x80 Kanallı Boru Bilezik
30x80 Kanallı Pipe Ring



*** WK 17-16**

25x60 Cam Kanallı Profil Tapası
25x60 Profile Plug



*** WK 17-17**

30x80 Cam Kanallı Profil Tapası
30x80 Profile Plug



*** WK 17-18**
27x20 Profil Tapası
27x20 Profile Plug



*** WK 17-19**
Çiftli Alt Baza Profil Tapası
Dual Lower Base Profile Plug



*** WK 17-20**
Tekli Alt Baza Profil Tapası
Single Lower Base Profile Plug



*** WK 18-08**
14x14 Kare Emniyet Tutamağı
14x14 Square Safety Handle



*** WK 18-09**
14x14 Kare Çiftli Emniyet Tutucu
14x14 Square Double Safety Handle



*** WK 18-10**
14x14 Emniyet Tutamağı
14x14 Safety Handle



*** WK 18-11**
14x14 Emniyet Tutamağı
14x14 Safety Handle



*** WK 19-18**
70x70 Kare Baba Tapası
70x70 Square Newel Plug



*** WK 19-19**
70x70 Kare Baba Tapası Dekorlu
70x70 Square Newel Plug Decor



*** WK 19-20**
70x70 Dekorlu Kristal Topuz
70x70 Decor Crystal Plug



*** WK 19-21**
14x14 Dekorlu Tapa
14x14 Decoretad Plug



*** WK 17-22**
25x50 Dikme Tapası
25x50 Strut's Plug



* WK 21-03

70x70 Kare Baba Profil (1 MT)
70x70 Square Newel Profile (1 MT)



* WK 21-04

32x25 Kare Boru Bağlantı Takozu
32x25 Square Pipe Connection



* WK 21-05

25x60 Bağlantı Takozu
25x60 Connection Wedge



* WK 22-10

40x40 Yandan Bağlantı Mafsali
40x40 Side Connection Set



* WK 22-11

40x40 Yandan Bağlantı Takımı
40x40 Side Connection Kit



* WK 22-12

50'lik Duvar Bağlantı Takımı
Ø50 Pipe Wall Mountings



* WK 22-14

Kare Profil Yandan Bağlantı
Square Profile Side Connection



* WK 22-15

40x40 Kare Yandan Bağlantı
70x70 Square Newel Plug



* WK 22-16

40x40 Duvar Ara Bağlantı
40x40 Wall Inter Connection



* WK 22-17

40x40 Yandan Bağlantı (10cm)
40x40 Side Connection (10cm)



* WK 22-18

25x60/30x80 Duvar Bağlantı
25x60/30x80 Wall Side



* WK 22-19

40x40 Yandan Bağlantı (Eco)
40x40 Side Connection (Eco)



*** WK 22-20**
40x40 Yandan Bağlantı (15cm)
40x40 Side Connection (15cm)



*** WK 22-21**
25x50 Yandan Bağlantı (15cm)
25x50 Side Connection (15cm)



*** WK 25-13**
Kare Çiftli Spider Takımı
Square Double Spider Team



*** WK 25-13/1**
Çiftli Spider Takımı
Double Spider Glass Rail



*** WK 25-14**
Kare Tekli Spider Takımı
Square Profil Single Spider Kit



*** WK 25-14/1**
Tekli Spider Takımı
Single Spider Glass Grab Rail



*** WK 25-15**
Hareketli Spider Kare Dikme
Square Strut Glass Grip With Allen



*** WK 25-16**
Kare Kapaklı Cam Tutamağı
Square Glass Fastener With Cover



*** WK 25-16/A**
Cam Tutamağı 8-10 mm
Glass Handle 8-10 mm



*** WK 25-17**
25x60/30x80 Spider Takım
25x60/30x80 Glass Spider Kit



*** WK 25-18**
25x60/30x80 Spiderli Mafsal
25x60/30x80 Spider Jointed



*** WK 25-20**
Kare Alyanlı Cam Tutamağı
Square Glass Handle Pillar



* WK 25-21

Kare Dikme Cam Tutamağı
Square Erection Glass Handle



* WK 25-22

Kare Emniyet Tutamaklı Spider
Square Safety Handle Spider



* WK 26-10

30x80 Kare Çamaşılık
30x80 Square Laundry Hanger



* WK 26-11

25x60 Kare Çamaşılık
25x60 Square Laundry Hanger



* WK 26-12

25x60 Boru Contası (4096)
25x60 Pipe Gasket for (4096)



* WK 26-13

25x60 Boru Contası (4107)
25x60 Pipe Gasket for (4107)



* WK 26-15

25x60 Boru Contası (4893)
25x60 Pipe Gasket for (4893)



* WK 26-16

30x80 Boru Contası (4894)
30x80 Pipe Gasket for (4894)



* WK 28-01

30x55 Kare Dikme Takımı (85cm)
30x55 Square Planting Kit (85cm)

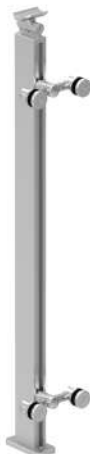

* WK 28-02

30x55 Spider Dikme Takımı (85cm)
30x55 Square Planting Kit (85cm)



* WK 28-03

40x40 4 Şeritli Dikme (85cm)
40x40 4 Safety Handle (85cm)



* WK 28-04

40x40 Cam Tutamaklı Dikme (85cm)
40x40 Glass Handle Strut's (85cm)



* WK 28-05

40x40 Çiftli Cam Tutamaklı (85cm) 40x40 Double Glass Handle (85cm)



* WK 28-06

40x40 Kare Dikme Takımı 40x40 Square Planting Team



* WK 28-09

14x14 Kare Dikme Takımı (100cm) 14x14 Square Planting Kit (100cm)



* WK 28-07

70x70 Kare Baba Takımı (120cm) 70x70 Square Newel Tema (120cm)

UYGULAMA DETAYLARI Applications Details



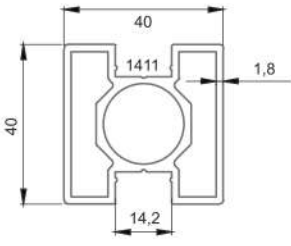

*** 1410**
40x40 Kare Dikme Profili (1,8mm)
1,188 kg/mt

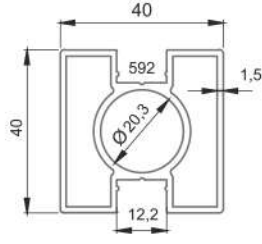

*** 5434**
40x40 Kare Dikme Profili (1,5mm)
1,020 kg/mt

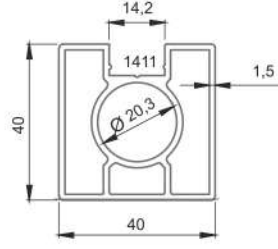

*** 5678**
40x40 Kare Tek Kanal Dikme Profili (1,5mm)
1,046 kg/m

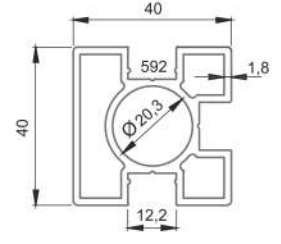

*** 591**
40x40 Kare Profili (1,8mm)
1,183 kg/mt

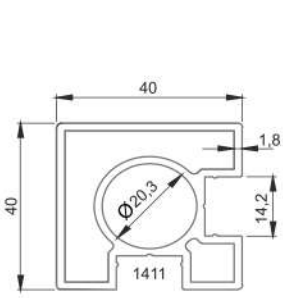

*** 4699**
40x40 Kare Dikme Profili (1,8mm)
1,156 kg/mt

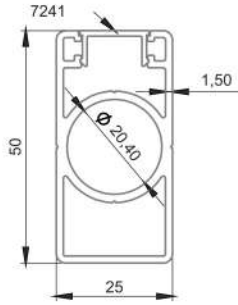

*** 7253**
25x50 Tek Kanallı Dikme
0,872 kg/mt

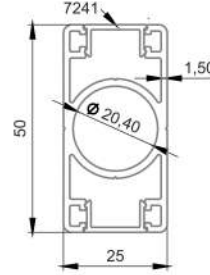

*** 7252**
25x50 Çift Kanallı Dikme
0,857 kg/mt

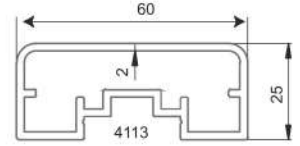

*** 4107**
25x60 Kare Profil
1,041 kg/mt

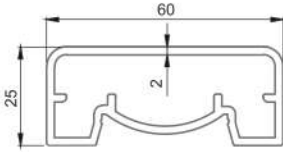

*** 4162**
25x60 Kare Profil
1,013 kg/mt

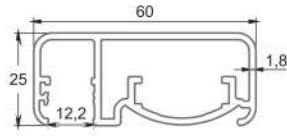

*** 3626**
25x60 Kare Profil Cam Kanallı
0,976 kg/mt

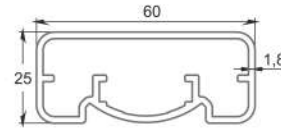

*** 3627**
25x60 Kare Profil Ay Bağlantılı
0,938 kg/mt

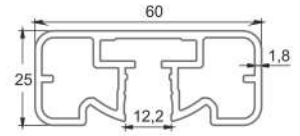

*** 3628**
25x60 Kare Profil
1,108 kg/mt

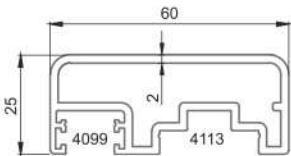

*** 4096**
25x60 Kare Profil
1,072 kg/mt

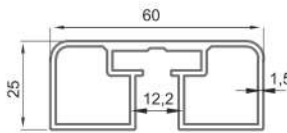

*** 4893**
25x60 Kare Cam Kanallı Profil
0,931 kg/mt

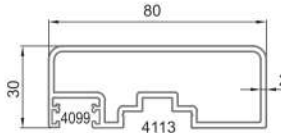

*** 4761**
30x80 Kare Profil
1,322 kg/mt

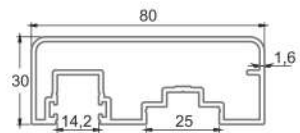

*** 5989**
30x80 Kare Profil
1,217 kg/mt

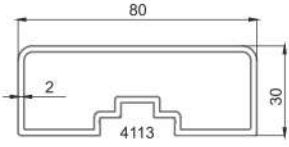

*** 10056**
30x80 Kare Profil
1,242 kg/mt

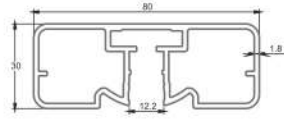

*** 3630**
30x80 Kare Profil
1,397 kg/mt

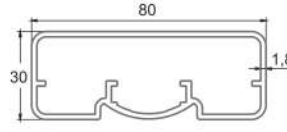

*** 3631**
30x80 Kare Profil
1,183 kg/mt

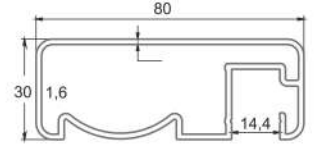

*** 1000**
30x80 Kare Profil
1,149 kg/mt

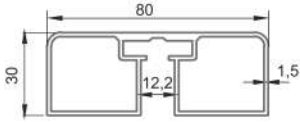

*** 4894**
30x80 Kare Cam Kanallı Profil
1,187 kg/mt

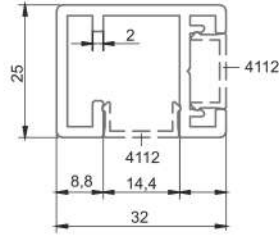

*** 4105**
25x32 Kare Cam Profil
0,588 kg/mt

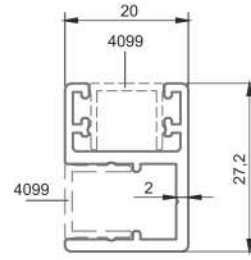

*** 4097**
27x20 Kare Cam Profil
0,420 kg/mt

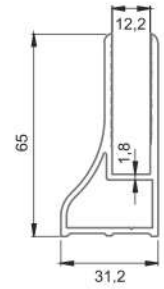

*** 4891**
Alt Etek Profili Tekli
1,054 kg/mt

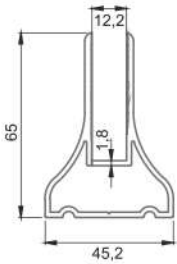

*** 4892**
Alt Etek Profili Çiftli
1,196 kg/mt

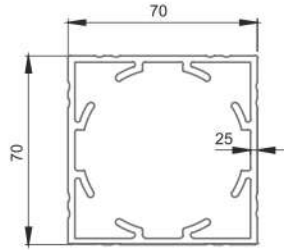

*** 4117**
70x70 Kare Profil
2,439 kg/mt

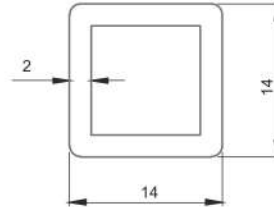

*** 1409**
14x14 Kare Profil
0,258 kg/mt

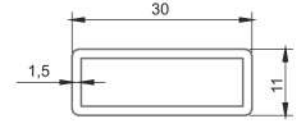

*** 2824**
11x30 Kare Profil
0,307 kg/mt

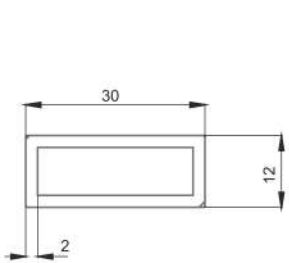

*** 10059**
12x30 Kare Profil
0,411 kg/mt

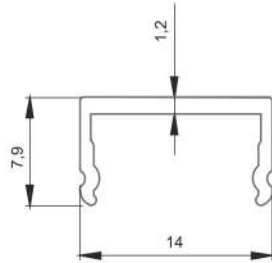

*** 1411**
Kare Dikme Kapak
0,080 kg/mt

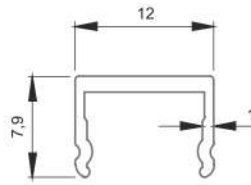

*** 592**
Kare Dikme Kapak
0,073 kg/mt

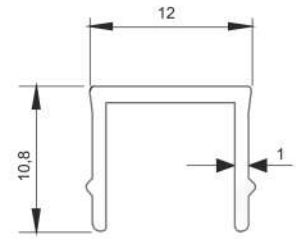

*** 4099**
Kapak
0,094 kg/mt

KARE KÜPEŞTE PROFİLLERİ Square Railing Profiles

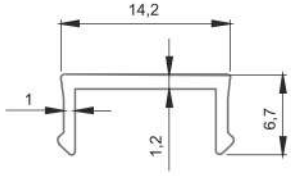

*** 4112**
Kapak
0,078 kg/mt

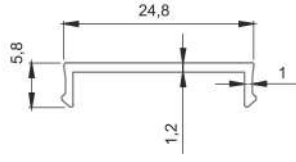

*** 4113**
Kapak
0,108 kg/mt

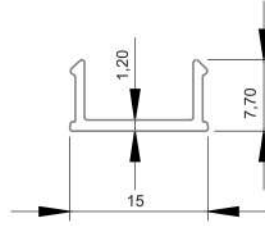

*** 7241**
Kapak
0,084 kg/mt

UYGULAMA DETAYLARI Applications Details



www.walmco.com - www.walmcoal.com



ELİPS KÜPEŞTE AKSESUARLARI

ELLIPSE RAILING ACCESSORIES

- Dikme ve Profil Flanşları
- Strut's and Profile Flange
- Bilezikler ve Mafsal Bağlantılar
- Rings and Joint Connection
- Dirsek ve Dönüş Bağlantıları
- Elbow and Return Connections
- Tapalar ve Kapaklar
- Plug and Covers
- Cam Tutamakları ve Aksesuarlar
- Glass Handle and Accessories
- Profiller
- Profiles



*** WE 10-01**
30x50 Elips Dikme Flaşı
30x50 Ellipse Strut's Flange



*** WE 10-02**
30x80 Elips Duvar Flaşı
30x80 Ellipse Wall Flange



*** WE 10-03**
30x80 Elips Cam Kanallı Flaş
30x80 Ellipse Glass Channel Flange



*** WE 10-04**
30x80 Hareketli Duvar Flaşı
30x80 Moving Wall Flange



*** WE 10-05**
14x24 Duvar Flaşı
14x24 Wall Flange



*** WE 13-01**
30x50 Hareketli Mafsal Takımı
30x50 Moving Joint Connection



*** WE 14-01**
30x50 Sabit Mafsal Takımı
30x50 Moving Joint Connection



*** WK 14-02**
30x50 Dikme Yandan Mafsal
30x50 Strut's Movable Joint



*** WE 15-01**
14x24 Hareketli Dönüş Dirsek
14x24 Movable Turning Elbow



*** WE 15-02**
30x30 90° Cam Kanal Dönüş
30x30 90° Glass Channel Return



*** WE 15-03**
30x30 90° Dönüş Dirsek
30x30 90° Return Elbow



*** WE 15-05**
30x80 Hareketli Köşe Bağlantı
30x80 Movable Corner Connection



* WE 15-06

30x80 Çoklu Dönüş
30x80 Multi Angle Turn



* WE 15-07

30x80 Çok Açılı Dönüş
30x80 Multi Angle Turn



* WE 15-08

30x80 Elips 90° Dönüş Dirsek
30x80 Ellipse 90° Turning Elbow



* WE 15-09

30x80 Cam Kanallı 90° Dönüş
30x80 Glass Channel 90° Turning



* WE 15-10

30x80 Cam Kanallı 90° Dönüş
30x80 Glass Channel 90° Turning



* WE 15-11

30x80 90° Dönüş
30x80 90° Turning



* WE 15-12

30x80 135° Hareketli Dönüş
30x80 135° Movable Turning



* WK 15-13

30x80 90° Sağ Hareketli Dönüş
30x80 90° Right Movable Turning



* WE 15-14

30x80 90° Sol Hareketli Dönüş
30x80 90° Left Movable Turning



* WE 15-15

30x80 90° Çok Hareketli Dönüş
30x80 90° Multi Movable Turning



* WE 16-01

14x24 Elips Profil Bağlantısı
14x24 Ellipse Profile Connection



* WE 16-02

30x30 Elips Profil Bilezik
30x30 Ellipse Profile Ring



*** WE 16-03**
30x30 Ortadan Kanallı Bilezik
30x30 Middle Channel Ring



*** WE 16-04**
30x80 Profil Bilezik
30x80 Profile Ring



*** WE 16-05**
30x80 Ortadan Kanallı Bilezik
30x80 Middle Channel Ring



*** WE 16-06**
30x80 Yandan Cam Kanallı Bilezik
30x80 Side Glass Channel Ring



*** WE 16-07**
30x80 Profil Uzun Bilezik
30x80 Profile Long Ring



*** WE 17-01**
14x24 Elips Profil Tapası
14x24 Ellipse Profile Plug



*** WE 17-02**
30x30 Elips Profil Tapası
30x80 135° Movable Turning



*** WK 17-03**
30x50 Elips Dikme Tapası
30x50 Ellipse Strut's Plug



*** WE 17-04**
30x80 Elips Profil Tapası
30x80 Ellipse Profile Plug



*** WE 17-05**
30x80 Cam Kanal Tapası
30x80 Glass Channel Plug

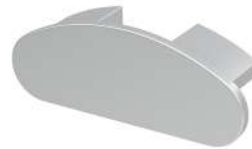

*** WE 17-06**
30x80 Elips Profil Tapası
30x80 Ellipse Profile Plug



*** WE 17-07**
14x24 Dekorlu Tapa
14x24 Decorated Plug



*** WE 18-01**
14x24 Açılı Emniyet Tutamağı
14x24 Ellipse Safety Handle



*** WE 18-02**
14x24 Emniyet Tutamağı
30x80 Profile Ring



*** WE 18-03**
14x24 Çiftli Emniyet Tutamağı
14x24 Double Safety Handle



*** WE 22-01**
30x50 Dikme Yandan Bağlantı (15cm)
30x50 Strut Side Wall Connection (15cm)



*** WE 25-01**
30x50 Kapaklı Cam Tutamağı
30x50 Cover Glass Handle



*** WE 25-02**
30x80 Cam Bağlantı Mafsali
30x80 Glass Connection Joint



*** WE 25-03**
30x50 Çiftli Spider Takımı
30x50 Double Spider Kit



*** WE 25-04**
30x50 Tekli Spider Takımı
30x50 Single Spider Kit

UYGULAMA DETAYLARI Applications Details



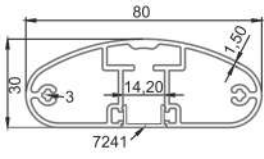

*** 7800**
30x80 Elips Profil
1,221 kg/mt

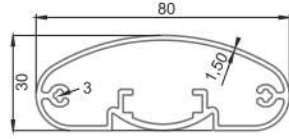

*** 7801**
30x80 Elips Profil
1,099 kg/mt

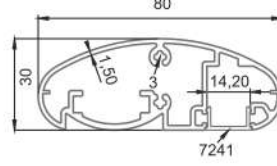

*** 7802**
30x80 Elips Profil
1,221 kg/mt

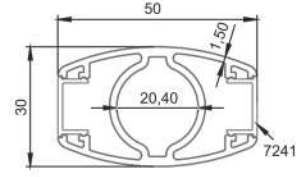

*** 7803**
30x50 Elips Çift Kanal Dikme Profili
1,149 kg/mt

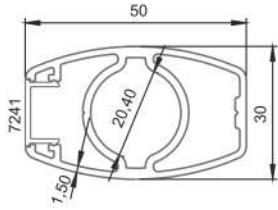

*** 7804**
30x50 Tek Kanal Dikme Profili
0,900 kg/mt

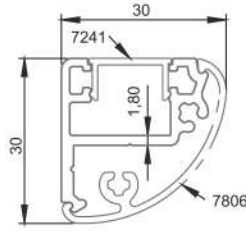

*** 7805**
30x30 Elips Profil
0,405 kg/mt

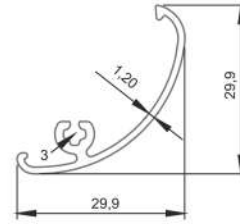

*** 7806**
30x30 Elips Profil Kapağı
0,243 kg/mt

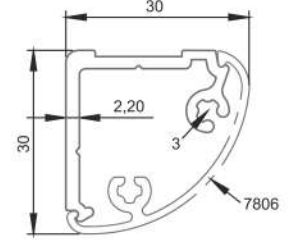

*** 7807**
30x30 Elips Profil
0,389 kg/mt

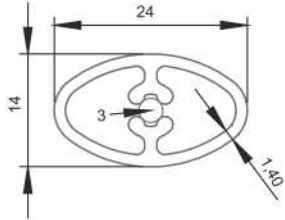

*** 7808**
14x24 Elips Profil
0,289 kg/mt

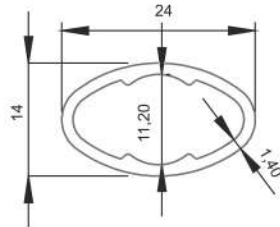

*** 7809**
70x70 Kare Profil
2,439 kg/mt

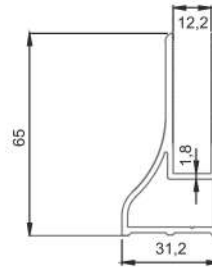

*** 4891**
Alt Etek Profili Tekli
1,054 kg/mt

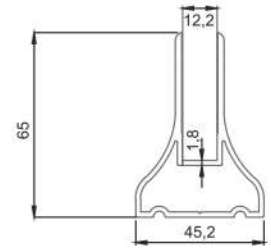

*** 4892**
Alt Etek Profili Çiftli
1,196 kg/mt

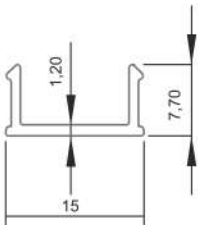

*** 7241**
30x50 Dikme Kapağı
0,084 kg/mt

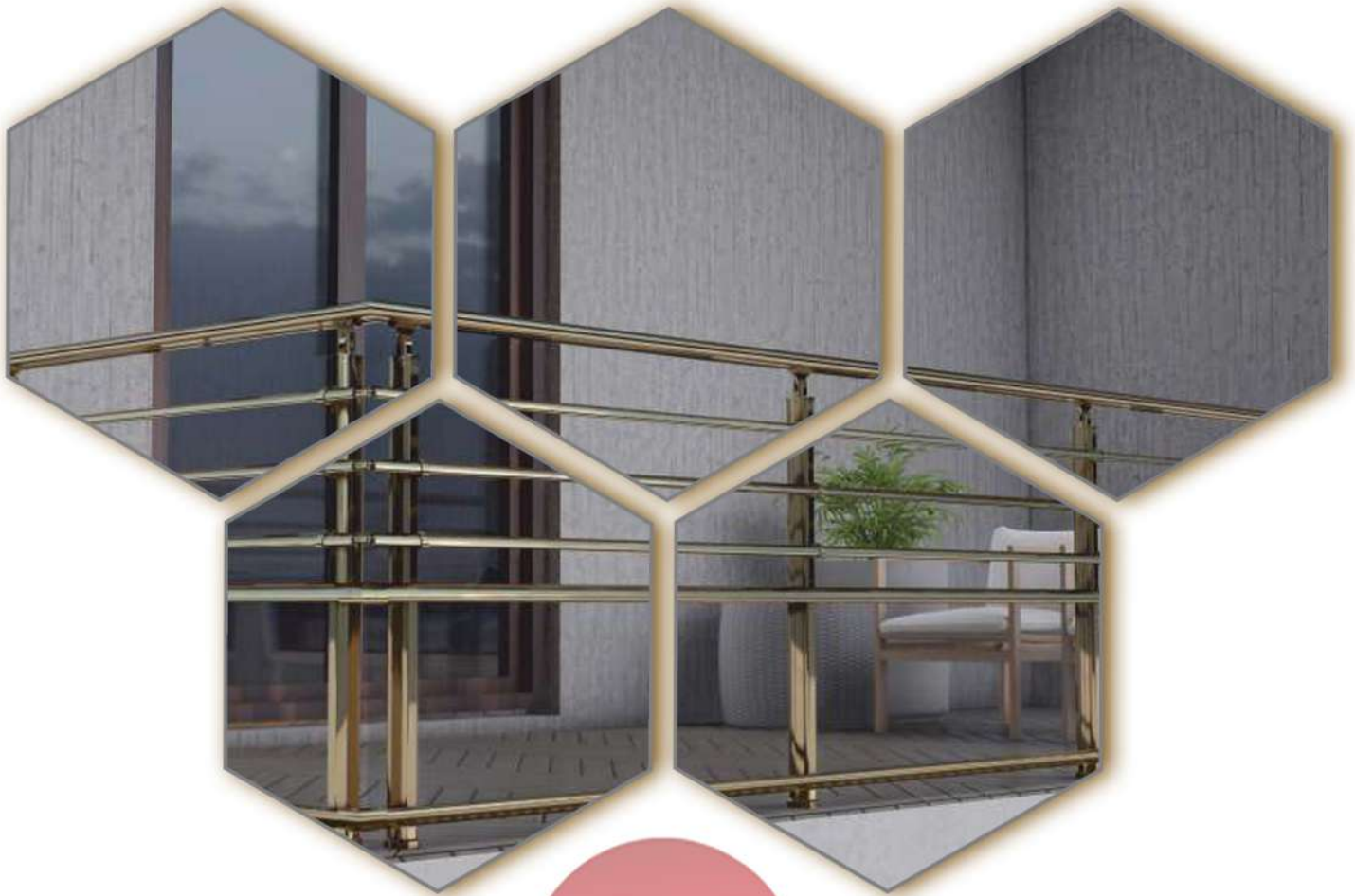



YUVARLAK KÜPEŞTE AKSESUARLARI

ROUND RAILING ACCESSORIES

- Dikme ve Profil Flanşları
- Strut's and Profile Flange
- Ara Dekorlar ve Mafsal Bağlantılar
- Decorated and Joint Connection
- Dirsek ve Dönüş Bağlantıları
- Elbow and Return Connections
- Tapalar ve Emniyet Tutucular
- Plug and Safety Handle
- Ankrajlar ve Aksesuarlar
- Anchoring and Accessories
- Cam Tutamakları ve Aksesuarlar
- Glass Handle and Accessories
- Profiller
- Profiles



* WA 10-01

40'lık Çift Tırnaklı Dikme Flanşı
Ø40 Claw Strut Flange



* WA 10-02

40'lık Tek Tırnaklı Dikme Flanşı
Ø40 Single Claw Strut Flange



* WA 10-03

40'lık Tırnaksız Dikme Flanşı
Ø40 Clawless Strut Flange



* WA 10-04

40'lık Dekorlu Dikme Flanşı
Ø40 Decorated Strut Flange



* WA 10-05

40'lık Boru Flanşı Lüks
Ø40 Luxury Pipe Flange



* WA 10-06

40'lık Açılı Dikme Flanşı
Ø40 Angular Strut Flange



* WA 10-07

40'lık Uzun Flanş
Ø40 Long Flange



* WK 10-08

40'lık Tırnaklı Dekorlu Flanş
Ø40 Claw Decorated Flange



* WA 10-09

40'lık Tırnaksız Dekorlu Flanş
Ø40 Clawless Decorated Flange



* WA 10-10

40'lık Boru Flanşı
Ø40 Pipe Flange



* WA 10-11

40'lık 3 Delikli Flanş
Ø40 Three-hole Flange



* WA 10-11/1

40'lık Flanş Kapağı
Ø40 Flange Cover



*** WA 10-12**
30'lik Boru Flanşı
Ø30 Pipe Flange



*** WA 10-13**
50'lik Boru Flanşı
Ø50 Pipe Flange



*** WA 10-14**
50'lik Boru Flanş Kapağı
Ø50 Pipe Flange Cover



*** WA 10-15**
50'lik 3 Delikli Boru Flanşı
Ø50 Strut Flange



*** WA 10-16**
40'lik Uzun Flanş
Ø40 Long Flange



*** WA 10-17**
40'lik Dekorlu Flanş
Ø40 Decor Flange



*** WA 10-18**
65'lik Dekorlu Flanş
Ø65 Decorated Flange



*** WA 10-20**
40'lik Gelin Dikme Dekor
Ø40 Bridal Sewing Decorated



*** WA 10-21**
40'lik İkiz Dikme Dekor
Ø40's Twin Pillar Decor



*** WA 10-22**
40'lik Paşa Dikme Dekor
Ø40 Pasha Pillar Decor



*** WA 10-23**
16'lik Boru Flanş
Ø16's Pipe Flange



*** WA 10-24**
16'lik 3 Delikli Boru Flanş
Ø16 Three-hole Pipe Flange



*** WA 10-25**
16'lık Boru Dekoru
Ø16 Pipe Decorated



*** WA 10-26**
30'lık 3 Delikli Boru Flanşı
Ø30's Three-hole Pipe Flange



*** WA 10-27**
40'lık Kapaklı Flanş
Ø40's Cover Flange



*** WA 10-32**
16'lık Tırtıllı Dekorlu Flanş
Ø16's Crawl Decorated Flange



*** WA 13-01**
30'lık Boru Mafsal Takımı
Ø30's Pipe Joint Set



*** WA 13-02**
40'lık Mafsal Takımı
Ø40 Strut Joint Set



*** WA 13-04**
40'lık Mafsal Takımı (Şapkalı)
Ø40 Sturt Joint Set (capped)



*** WA 13-05**
40'lık Dikme Mafsal Takımı
Ø40 Pipe Joint Set



*** WA 13-06**
40'lık Dikme Mafsal (şapkalı)
Ø40 Strut Joint Set (capped)



*** WA 13-07**
50'lık Boru Mafsal Takımı
Ø50's Pipe Joint Set



*** WA 13-08**
50'lık Boru Açılı Mafsal Takımı
Ø50 Pipe Angular Joint Set



*** WA 14-01**
40'lık Sabit Mafsal (şapkalı)
Ø40's Fixed Joint (capped)



*** WA 14-02**
40'lık Sabit Mafsal
Ø40's Fixed Joint



*** WA 14-04**
40'lık Dekorlu Sabit Mafsal
Ø40's Decorated Fixed Joint



*** WA 14-05**
40'lık Sabit Mafsal (Şapkalı)
Ø40's Fixed Joint (capped)



*** WA 14-06**
40'lık Dikme Sabit Mafsal
Ø40's Strut Fixed Joint



*** WA 14-07**
40x50 Ara Bağlantı
40x50 Strut Inter Connection



*** WA 14-08**
40x40 Ara Bağlantı
40x40 Strut Inter Connection



*** WA 14-09**
50x50 Ara Bağlantı
50x50 Strut Inter Connection



*** WA 14-10**
16x40 Ara Bağlantı
16x40 Strut Inter Connection



*** WA 14-11**
16x30 Ara Bağlantı
16x30 Strut Inter Connection



*** WA 14-12**
30x40 Ara Bağlantı
30x40 Strut Inter Connection



*** WA 14-15**
30x30 Ara Bağlantı
30x30 Strut Inter Connection



*** WA 14-16**
30x40 Dekorlu Ara Bağlantı
30x40 Decorated Inter Connection



*** WA 15-01**
16'lik 90° Dirsek
Ø16's 90° Elbow



*** WA 15-02**
16'lik 135° Dirsek
Ø16's 135° Elbow



*** WA 15-05**
50'lik 1/4 Dolu Dirsek
Ø50's 1/4 Connected Solid Elbow



*** WA 15-06**
50'lik 1/8 Dolu Dirsek
Ø50's 1/8 Connected Solid Elbow



*** WA 15-09**
50'lik 1/4 Boş Dirsek
Ø50's 1/4 Empty Elbow



*** WA 15-10**
50'lik 1/8 Boş Dirsek
Ø50's 1/8 Empty Elbow



*** WA 15-11**
50'lik 1/4 Şişme Dirsek
Ø50's 1/4 Inflatable Elbow



*** WA 15-12**
50'lik 1/8 Şişme Dirsek
Ø50's 1/8 Inflatable Elbow



*** WA 15-13**
30'luk 1/4 Şişme Dirsek
Ø30's 1/4 Inflatable Elbow



*** WA 15-14**
50'lik Ayarlı Küre Dirsek
Ø50's Adjustable Globe Elbow



*** WA 15-15**
16'lik Ayarlı Küre Dirsek
Ø16's Adjustable Globe Elbow



*** WA 15-16**
30'luk Ayarlı Küre Dirsek
Ø30's adjustable Globe Elbow



* WA 15-17

40'lik Ayarlı Küre Dirsek
Ø40's Adjustable Globe Elbow



* WA 15-18

50'lik Ayarlı Küre Dirsek
Ø50's Adjustable Globe Elbow



* WA 15-19

50'lik Ayarlı Köşe Dirsek
Ø50's Adjustable Corner Elbow



* WA 15-20

50'lik Ayarlı Küre Duvar Flaşı
Ø50's Adjustable Wall Flange



* WA 15-21

50'lik Ayarlı Küre Dirsek Boş
Ø50's Adjustable Elbow Empty

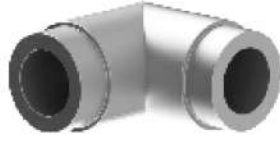

* WA 15-22

50'lik Dolu Dirsek
Ø50's Filled Elbow



* WA 15-23

50'lik 1/4 Kaynaklı Dirsek
Ø50's 1/4 Welded Elbow



* WA 15-23/A

50'lik 1/4 Kaynaklı Kanallı Dirsek
Ø50's 1/4 Welded Channel Elbow



* WA 16-01

16'lik Bilezik
Ø16's Sleeve



* WA 16-02

50'lik Bilezik
Ø50's Sleeve



* WA 16-03

50'lik Uzun Bilezik
Ø50's Long Sleeve



* WA 16-04

30'luk Bilezik
Ø30's Sleeve



*** WA 16-05**
16'lık Ara Bağlantı
Ø16's Inter Connection



*** WA 17-01**
16'lık Boş Boru Tapası
Ø16's Empty Pipe Plug



*** WA 17-02**
16'lık Dolu Boru Tapası
Ø16's Filled Pipe Plug



*** WA 17-03**
16'lık Küre Boru Tapası
Ø16's Spherical Pipe Plug



*** WA 17-04**
30'lık Boru Tapası
Ø30's Pipe Plug



*** WA 17-05**
40'lık Boru Tapası
Ø40's Pipe Plug



*** WA 17-06**
40'lık Dikme Tapası
Ø40's Strut Plug



*** WA 17-07**
50'lık Boru Tapası
Ø50's Pipe Plug



*** WA 17-09**
16'lık Mızrak Dekorlu Tapa
Ø16's Spear Decorated Plug



*** WA 17-10**
16'lık Topuz Dekorlu Tapa
Ø16's Mace Decorated Plug



*** WA 17-11**
50'lık Kanallı Boru Tapa
Ø50's Channel Pipe Plug



*** WA 17-12**
30'lık Dikme Tapa
Ø30's Strut Plug



* WA 17-13

30'lık Boru Tapası (dıştan)
Ø30's Pipe Plug



* WA 18-01

16'lık Tekli Emniyet Tutamağı
Ø16's Single Safety Handle



* WA 18-02

16'lık Çiftli Emniyet Tutamağı
Ø16's Double Safety Handle



* WA 18-03

16'lık Tekli Emniyet Tutamağı
Ø16's Single Safety Handle



* WA 18-04

16'lık Küre Emniyet Tutamağı
Ø16's Spherical Safety Handle



* WA 17-05

16x30 Çiftli Emniyet Tutamağı
16x30 Single Safety Handle



* WA 18-06

3'lü Dikey Emniyet Tutamağı
3 Vertical Safety Handle



* WA 18-07

2'li Yatay Emniyet Tutamağı
2 Horizontal Safety Handle



* WA 18-11

16'lık İkili Hareketli Tutucu
Ø16's Dual Moving Safety Handle



* WA 18-12

Duvar Çiftli Emniyet Tutamağı
Wall Single Safety Handle



* WA 19-01

40'lık Dikme Dekorlu Tapa
Ø40's Strut Decorated Plug



* WA 19-03

50'lık Boru Dekorlu Tapa
Ø50's Pipe Decorated Plug



*** WA 19-04**
50'lik Boru Mızrak Tapa
Ø50's Pipe Rike Plug



*** WA 19-05**
65'lik Boru Dekorlu Tapa
Ø65's Pipe Decorated Plug



*** WA 19-06**
65'lik Boru Mızrak Tapa
Ø65's Pipe Rike Plug



*** WA 19-07**
50x60 Kristal Dekorlu Tapa
50x60 Crystal Decorated Plug



*** WA 19-08**
50x70 Kristal Dekorlu Tapa
50x70 Crystal Decorated Plug



*** WA 19-09**
60x70 Kristal Dekorlu Tapa
60x70 Crystal Decorated Plug



*** WA 19-10**
65x80 Kristal Dekorlu Tapa
65x80 Crystal Decorated Plug



*** WA 19-11**
40x50 Kristal Dekorlu Tapa
40x50 Crystal Decorated Plug



*** WA 19-12**
16'lik Mızrak Kristal Tapa
Ø16's Spear Crystal Plug



*** WA 20-01**
65'lik Tırtıllı Boru (1mt)
Ø65's Knurled Pipe (1mt)



*** WA 21-01**
50'lik Dolu Dirsek Bağlantısı
Ø50's Pipe Lateral Connection



*** WA 21-02**
45'lik Dekorlu Tapa Bağlantısı
Ø45's Decorated Plug Connection



*** WA 21-03**
65'lik Dekorlu Tapa Bağlantısı
Ø65's Decorated Plug Connection



*** WA 22-01**
50'lik Boru L Açılı Bağlantı
Ø50's Angled L Connection



*** WA 22-02**
50'lik Boru Duvar Dibi Takımı
Ø50's Pipe Wall-Side Set



*** WA 22-03**
50'lik Boru L Bağlantı
Ø50's Pipe L Connection



*** WA 22-04**
40'lik Dikme Yandan Bağlantı
Ø40's Strut Side Connection



*** WA 22-05**
50'lik Boru T Bağlantı
Ø50's Pipe T Connection



*** WA 22-06**
40'lik Dikme Yandan Bağlantı
Ø40's Strut Side Connection



*** WA 22-06/A**
40'lik Yandan Bağlantı (10cm)
Ø40's Side Connection (10cm)



*** WA 22-06/B**
40'lik Yandan Bağlantı (15cm)
Ø40's Side Connection (15cm)



*** WA 22-07**
Çiftli Duvar Ara Bağlantısı
Double Wall Interconnection



*** WA 22-08**
Duvar Pulu
Wall Washer



*** WA 22-09**
Tekli Duvar Ara Bağlantısı
Single Wall Interconnection



*** WA 22-10**
50'lik Cam Bağlantı Mafsali
Ø50's Glass Connection Joint



*** WA 22-11**
Cam Yandan Bağlantı Takımı
Glass Side Connection Set



*** WA 22-12**
50'lik Boru Duvar Takımı
Ø50's Pipe Wall Set



*** WA 22-13**
40'lik Boru Yandan Bağlantı Takımı
Ø40's Pipe Side Connection Set



*** WA 22-14**
40'lik Boru Hareketli Bağlantı
Ø40's Pipe Movable Connection



*** WA 23-01**
Kapı Menteşe
Door Hinge



*** WA 23-02**
Kapı Sürgü
Door Latch



*** WA 24-01**
40'lik Ahşap Ankraj Demiri
Ø40's Wood Anchoring Iron



*** WA 24-02**
30'lik Ankraj Demiri
Ø30's Anchoring Iron



*** WA 24-03**
40'lik Alüminyum Ankraj
Ø40's Aluminum Anchoring



*** WA 24-04**
40'lik Vidalı Ankraj Demiri
Ø40's Anchoring Iron With Screws



*** WA 24-05**
40'lik Ankraj Demiri
Ø40's Anchoring Iron



*** WA 24-06**
Yandan Ankraj Demiri
Side Anchoring Iron



*** WA 24-07**
40'lık Ankraj Demiri (14cm)
Ø40's Anchoring Iron (14cm)



*** WA 24-08**
40'lık Boş Ankraj (20cm)
Ø40's Empty Anchoring (20cm)



*** WA 24-09**
40'lık Boş Ankraj (14cm)
Ø40's Anchoring Iron (14cm)



*** WA 24-10**
40'lık Ahşap Ankraj Takımı
Ø40's Wood Anchoring Set



*** WA 25-01**
40'lık Dikmeye Cam Tutucu
Ø40's Strut Glass Handle



*** WA 25-02**
40'lık Boruya Cam Tutucu
Ø40's Pipe Glass Handle



*** WA 25-03**
Tekli Cam Tutamağı
Single Glass Handle



*** WA 25-04**
Çiftli Cam Tutamağı
Double Glass Handle



*** WA 25-05**
Cam Stobu
Glass Stop



*** WA 25-06**
40'lık Boruya Kapaklı Cam Tutucu
Ø40's Pipe Glass Lid Handle



*** WA 25-06/A**
Kapaklı Cam Tutucu (8-10mm)
Glass Lid Handle (8-10mm)



* WA 25-07

40'lık Alyanlı Cam Tutamağı
Ø40's Glass Handle With Allen



* WA 25-08

Emniyet Tutamaklı Spider
Safety Handle Spider



* WA 25-09

Tekli Spider Cam Tutamağı
Single Spider Glass Handle



* WA 25-10

Çiftli Spider Cam Tutamağı
Double Spider Glass Handle



* WA 25-11

Frezeli Spider Cam Tutamağı
Milled Spider Glass Grab Rail



* WA 25-12

40'lık Boru Spider Cam Tutucu
Ø40's Pipe Spider Glass Handle



* WA 25-13

Spider Cam Bağlantı Mafsalı
Spider Glas Connection Joint



* WA 25-16

Çapraz Göbek Bağlantı
Transverse Hub Connector



* WA 25-19

16'lık Pul
Ø16's Washer



* WA 25-20

30'luk Frezeli Ara Bağlantı
Ø30's Milled Intermediate Connect



* WA 26-01

M10x100 Alyan Vida
M10x100 Allen Screw



* WA 26-04

Çelik Dübel
Steel Dowel



* WA 26-05

M12 Somun
M12 Nut



* WA 26-06

M12 Pul
M12 Washer



* WA 26-07

4,2x45 Montaj Vidası
4,2x45 Mounting Screw



* WA 26-08

3,9x19 Montaj Vidası
3,9x19 Mounting Screw



* WA 27-01

Epoksi Yapıştırıcı Harç
Epoxy Adherence Grout



* WA 27-02

Mermer Yapıştırıcı Harç
Marble Adherence Grout



* WA 27-03

Epoksi Tabancası
Epoxy Gun



* WA 28-01

40'lık Dikme 4 Emniyetli (85cm)
Ø40's Strut 4 Safety Handle (85cm)



* WA 28-02

40'lık Dikme Tekli Cam Tutamaklı (85cm)
Ø40's Strut Single Glass Handle (85cm)



* WA 28-03

40'lık Dikme Çiftli Cam Tutamaklı (85cm)
Ø40's Strut Double Glass Handle (85cm)



* WA 28-04

40'lık Dikme Takımı (85cm)
Ø40's Strut Set (85cm)

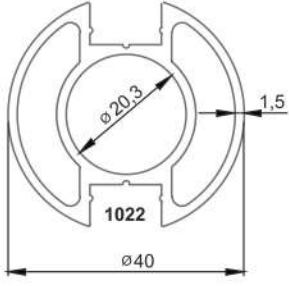

*** 1565**
40'lık Çift Kanallı Dikme 1,5mm
0,911 kg/mt

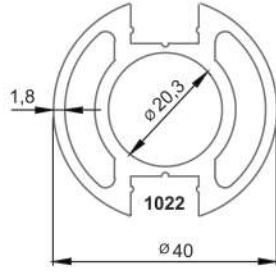

*** 1010**
40'lık Çift Kanallı Dikme 1,8 mm
1,143 kg/mt

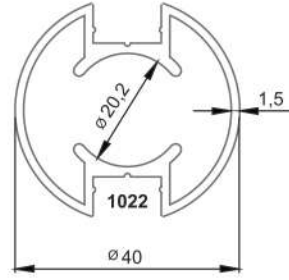

*** 1599**
40'lık Çift Kanal Dikme 1,5mm
0,762 kg/mt

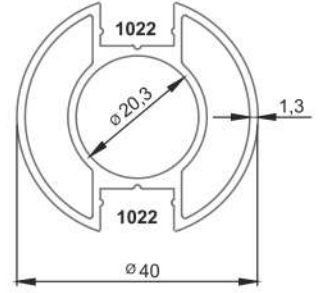

*** 2879**
40'lık Çift Kanal Dikme 1,3mm
0,755 kg/mt

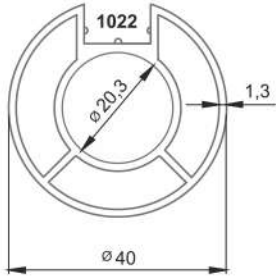

*** 2246**
40'lık Tek Kanal Dikme 1,3mm
0,806 kg/mt

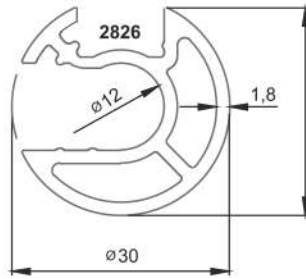

*** 2825**
30'luk Dikme Profil Camlı 1,8mm
0,598 kg/mt,

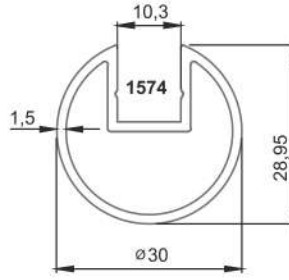

*** 1570**
30'luk Kanallı Profil 1,5mm
0,467 kg/mt

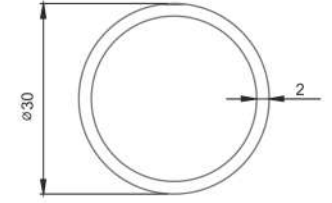

*** 1571**
30'luk Boru 2mm
0,477 kg/mt

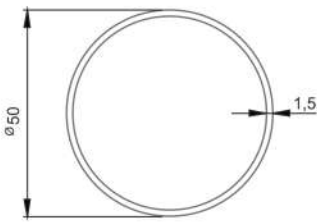

*** 2622**
50'lik Boru 1,5 mm
0,738 kg/mt

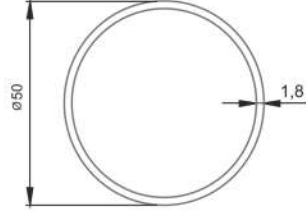

*** 2984**
50'lik Boru 1,8 mm
0,738 kg/mt

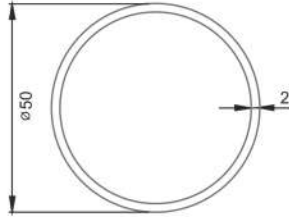

*** 896**
50'lik Boru 2 mm
0,817 kg/mt

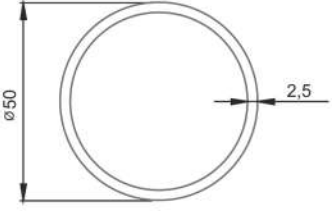

*** 917**
50'lik Boru 2,5mm
1,011 kg/mt

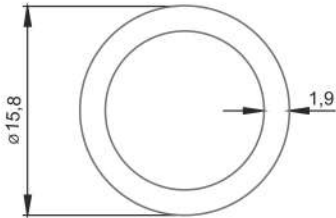

*** 1234**
16'lık Boru 1,9mm
0,224 kg/mt

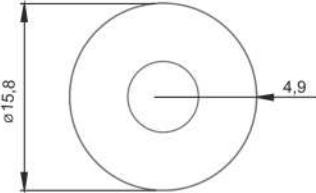

*** 916**
16'lık Boru 4,9mm
0,454 kg/mt

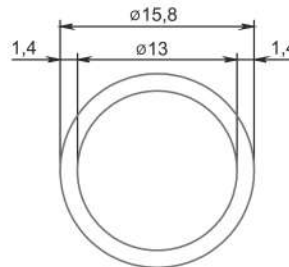

*** 2878**
16'lık Boru 1,4mm
0,172 kg/mt

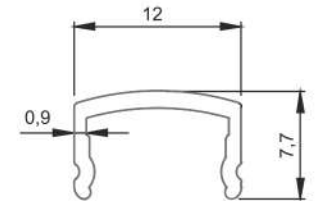

*** 1022**
40'lık Dikme Kapağı
0,073 kg/mt

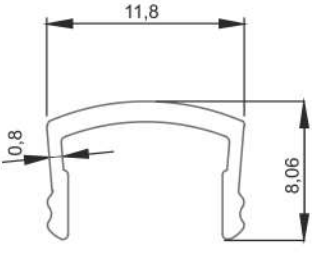

*** 2826**
30'luk Dikme Kapağı
0,072 kg/mt

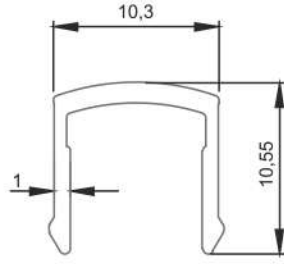

*** 1574**
30'luk Kanallı Boru Kapağı
0,081 kg/mt

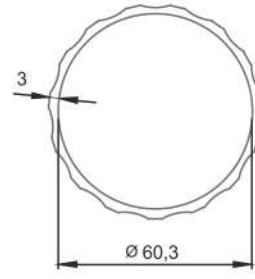

*** 1036**
65'lik Tırtıllı Boru
1,377 kg/mt

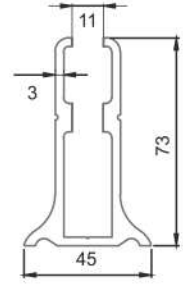

*** 822**
Alt Etek Profili
1,862 kg/mt

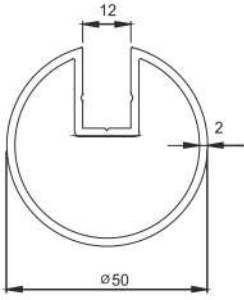

*** 4723**
50'lik Kanallı Profil 2mm
1,026 kg/mt

UYGULAMA DETAYLARI Application Details





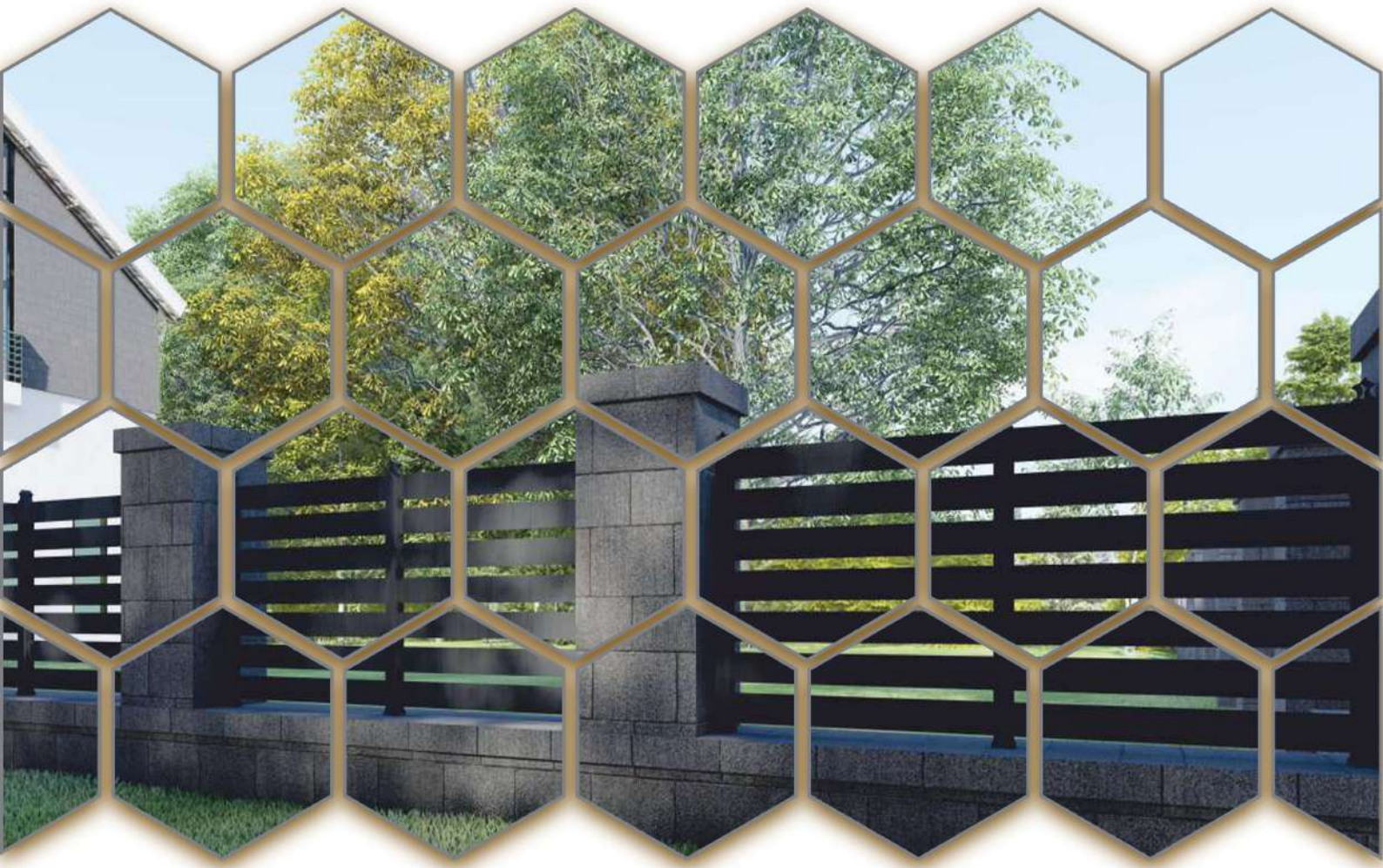

BAHÇE ÇİT SİSTEMLERİ

GARDEN FENCE SYSTEMS

- Dikme ve Profil Flanşları
- Strut's and Profile Flange
- Tapalar ve Mentешeler
- Plug and Hinge
- Ankrajlar
- Anchoring
- Profiller
- Profiles



* WB 10-01

60x60 Dikme Flanşı
60x60 Pillar Flange



* WB 10-02

14x100 Flanş
14x100 Flange



* WB 11-01

60x60 Dikme Tapası
60x60 Pillar Plug



* WB 11-02

60x60 Çam Dekorlu Tapa
60x60 Pine Decorated Plug



* WB 11-03

60x60 Damla Dekorlu Tapa
60x60 Drop Decorated Plug



* WB 11-04

14x100 Tapa
Pillar Flange



* WB 11-05

14x100 Çam Dekorlu Kapa
14x100 Pine Decorated Plug



* WB 11-06

14x100 Damla Dekorlu Tapa
14x100 Drop Decorated Plug



* WB 11-07

Kapı Mentşesi
Door Hinge



* WA 24-05

Ankraj 20 cm
Anchorage 20cm



* WK 10-42

40x40 Flanş Ahşap Ankraj
40x40 Flange Wood Anchorage

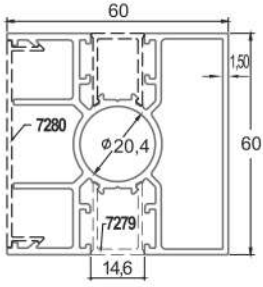

*** 7270**
60x60 Çit Dikme Profili
1,639 kg/mt

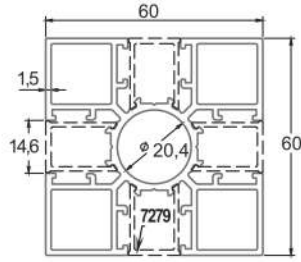

*** 7271**
60x60 Çit Dikme Profili
1,937 kg/mt

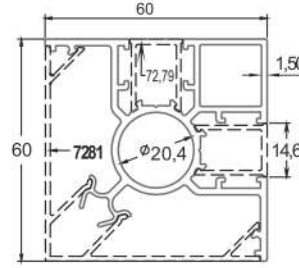

*** 7272**
60x60 Çit Dikme Profili
1,376 kg/mt

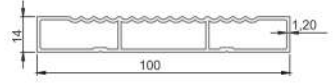

*** 7274**
100x14 Çit Profili
0,848 kg/mt

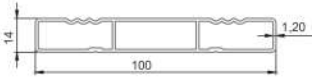

*** 7275**
100x14 Çit Profili
0,830 kg/mt

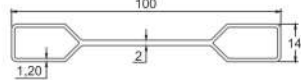

*** 7276**
100x14 Çit Profili
0,706 kg/mt

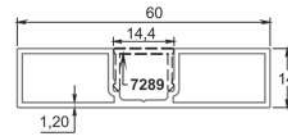

*** 7277**
60x14 Çit Profili
0,523 kg/mt

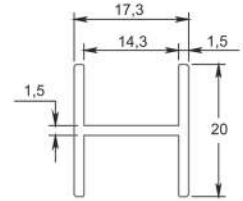

*** 7278**
20x17,3 Çit Profili
0,220 kg/mt

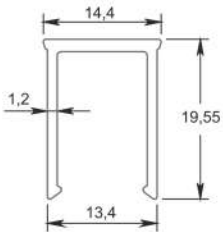

*** 7279**
Kapak
0,175 kg/mt

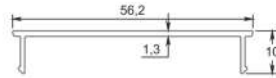

*** 7280**
Kapak
0,246 kg/mt

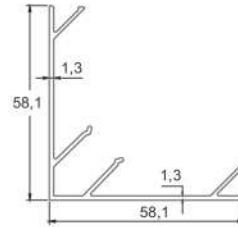

*** 7281**
Kapak
0,580 kg/mt

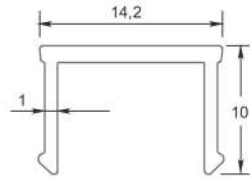

*** 7289**
Kapak (7277 Profil Kapağı)
0,098 kg/mt

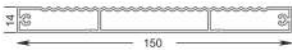

*** 7290**
14x150 Çit Profili
1,281 kg/mt

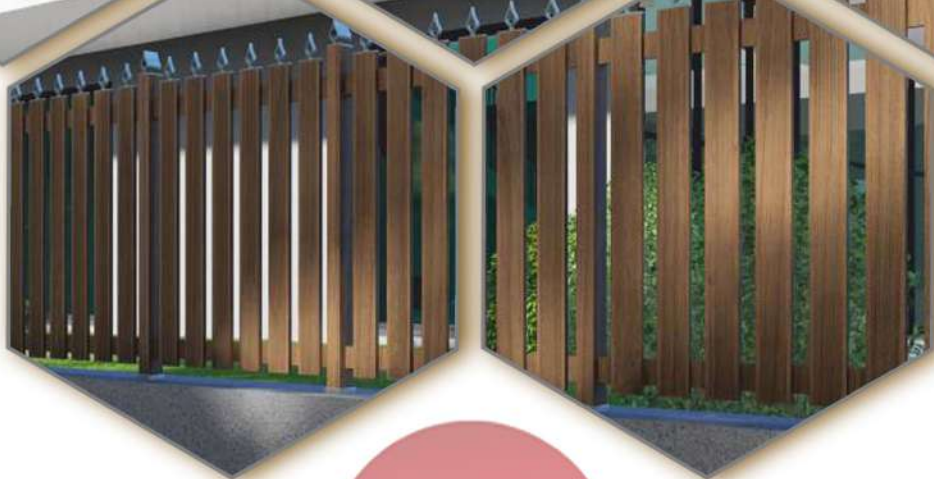



WALMCO

— PLEXI & ALUMINUM SYSTEMS —

Fabrika & Showroom

Dudullu OSB.Esenşehir Mah. Kürkçüler Cad. No:96/1

Ümraniye - İSTANBUL - TÜRKİYE

Tel:+90 (216) 909 28 34

info@walmco.com

www.walmco.com

